



**CARBEL**  1957

*Desde 1957*

INSERTABLES Y ESTUFAS  
INSETS & STOVES

**65**   
AÑOS - YEARS  
1957 - 2022



Instalaciones de más de 6000 m<sup>2</sup>, equipadas con las mejores tecnologías.  
*Facilities of more than 6000 m<sup>2</sup>, equipped with the best technologies*

## DESDE 1957, UNA EMPRESA EN CONSTANTE EVOLUCIÓN

65 años en el mercado, una de las empresas más longevas del sector.

Sin duda el éxito de CARBEL se debe al vínculo de confianza entre cliente, producto y empresa.

Nuestro objetivo ha sido siempre el de ofrecer a los clientes aparatos de calefacción a leña con unos elevados niveles de rendimiento, aportando soluciones competitivas y acordes a la realidad del mercado.

Con el carácter de nuestro fundador y caminando hacia el futuro.

Con el paso del tiempo, nuestros modelos han ido evolucionando hasta nuestro actual catálogo con más de 60 referencias, muestra de esta evolución es la creciente presencia de CARBEL a nivel nacional y nuestra expansión internacional.

Sin embargo, el carácter de nuestro fundador basado en la seriedad en el trabajo, junto con el trato directo y familiar con los clientes sigue tan arraigado en la empresa como el primer día.

## SINCE 1957, A COMPANY IN CONSTANT EVOLUTION

65 years in the market make us one of the longest standing companies in our sector.

CARBEL's success is the result of the trust that exists between our customers and our company.

Our goal has always been to offer our customers the most efficient wood heating stoves and provide the most competitive solutions.

*Bearing values of our founder in mind, we focus on the future.*

*As time goes by, our models have evolved to our current range with more than 60 references. An evidence of our evolution is our growing presence in our national, and international markets.*

*However, the values of our founder, combining strong work ethics with direct and closer relationship with our customers are still at the heart of the company.*



Marcaje europeo  
European marking

Norma Standard:  
EN 13240

Norma europea de referimiento para estufas de combustibles sólidos  
European standard of reference for solid fuel stoves

Norma Standard:  
EN 13229

Norma europea de referimiento para insertables de combustibles sólidos  
European standard for solid fuel inset stoves

Norma Standard:  
EN 16510

Equipos de calefacción residencial alimentados con combustible sólido  
Residential solid fuel burning appliances.



Productos que cumplen con la normativa alemana Stufe 2 BImSchV  
Device compliant with German norm Stufe 2 BImSchV



Miembro de la Asociación española de fabricantes de estufas, chimeneas y cocinas para combustibles sólidos  
Member of the Spanish Association of solid fuel burning stove, fireplace and cooker manufacturers



Productos que ya cumplen con la normativa ECODESIGN 2022  
Ecodesign ready products





## CARBEL, PRESENTE Y FUTURO DE UNA GRAN EMPRESA

Nuestra evolución y saber hacer a lo largo de estos 65 años se ven reflejados en nuestro equipo humano, nuestros procesos de fabricación, materiales y maquinaria que continuamente han ido mejorando en una clara apuesta por el futuro.

### Equipo humano

Sin duda, el principal activo de CARBEL es su equipo humano. Desde los departamentos de producción, investigación y desarrollo, administración y ventas; el cuidado en los procesos y la vocación hacia el cliente son las máximas.

### Instalaciones

Con unas instalaciones de más de 6000 m<sup>2</sup>, equipadas con las mejores tecnologías, desarrollamos íntegramente los procesos de diseño y fabricación de nuestros modelos. La automatización en la producción nos permite asegurar los mejores estándares de calidad que siempre han caracterizado a nuestros productos.

### Investigación y desarrollo

Nuestra oficina técnica, trabaja constantemente en la mejora y perfeccionamiento de la gama de productos con el fin de ofrecer soluciones fiables y competitivas. Disponemos de un laboratorio de ensayos que nos permite testar y perfeccionar nuestros modelos antes enviarlos a los laboratorios de certificación.

### Stock permanente

Conscientes de la importancia de satisfacer las necesidades de nuestros clientes en el momento adecuado, disponemos de un stock permanente de producto acabado.

## CARBEL, PRESENT AND FUTURE OF A GREAT FAMILY COMPANY

*Our development over the past 65 years is reflected in our staff, our manufacturing processes, materials and machinery have been continuously improving as a clear commitment to the future.*

### Human team

*Without doubt, CARBEL's main asset is its staff. Production, R&D, administration or sales they all share the same philosophy for excellence and care for the customer.*

### Facilities

*With facilities of more than 6000 m<sup>2</sup>, equipped with the latest technology, we have total control over the design and manufacturing processes and our high level of automation ensures the best quality and consistency in all our products.*

### Research and development

*Our technical department works constantly to improve our product range in order to offer reliable and competitive solutions. We have our own testing laboratory to test and improve our products before sending them for certification.*

### Permanent stock

*Knowing how important it is to satisfy the needs of our customers quickly, we maintain a permanent stock of finished product.*

Descubre más sobre Carbel en sus redes sociales.  
*Learn more about Carbel in their social media.*  
[www.carbel.net](http://www.carbel.net)

¡Síguenos!  
Follow us!



INSERTABLES - CASSETTES / INSETS

NOVEDAD



I-100



I-80



I-70



I-60



KRONOS 100 D.C. /  
DOUBLE-SIDED



KRONOS 80 D.C. /  
DOUBLE-SIDED

HOGARES / FIREPLACES

NUEVO DISEÑO



T-100-2



T-80-2



T-70-2



HK-100 D.C. / DOUBLE-SIDED



VISION

SERIE RK Y ESTUFAS / RK SERIES AND STOVES



RK-100 LEÑERA /  
WITH LOG BOX



RK-80 LEÑERA /  
WITH LOG BOX



RK-70 LEÑERA /  
WITH LOG BOX



RK-60 LEÑERA /  
WITH LOG BOX



RK-100 PIE /  
FREE-STANDING



RK-80 PIE /  
FREE-STANDING



RK-70 PIE /  
FREE-STANDING



RK-100 D.C. / DOUBLE-SIDED



RK-80 D.C. /  
DOUBLE-SIDED



RA-100-2 SUSPENDIDO /  
SUSPENDED

NOVEDAD

RA-85-2 SUSPENDIDO /  
SUSPENDED



RA-85-2



RA-85-2 LEÑERA /  
WITH LOG BOX



ARES-2

NUEVO DISEÑO

ESTUFAS HORNO / STOVES WITH OVEN



ZEUS



ATLAS



ATLAS INSERTABLE / INSET



HERMES



KRONOS 70 D.C. /  
DOUBLE-SIDED



A-100-2



A-85-2



A-70-2



G-100



RK-100  
SUSPENDIDO /  
SUSPENDED



RK-80  
SUSPENDIDO /  
SUSPENDED



RK-70  
SUSPENDIDO /  
SUSPENDED



RK-60  
SUSPENDIDO /  
SUSPENDED



VISION



MAIA  
SLIM



MAIA  
CUBE



MAIA  
LARGE



MAIA  
ROUND



MAIA  
WALL

**INSERTABLES - CASSETTES**

**INSETS**

I-100 .....	8
I-80 .....	9
I-70 .....	10
I-60 .....	11
KRONOS 100 Doble Cara / <i>DOUBLE-SIDED</i> ..	12
KRONOS 80 Doble Cara / <i>DOUBLE-SIDED</i> ..	13
KRONOS 70 Doble Cara / <i>DOUBLE-SIDED</i> ..	13
A-100-2 .....	22
A-85-2 .....	23
A-70-2 .....	23

**HOGARES**

**FIREPLACES**

T-100-2 .....	16
T-80-2 .....	17
T-70-2 .....	18
HK-100 Doble Cara / <i>DOUBLE-SIDED</i> ...	20
VISION .....	24
G-100 .....	26

**SERIE RK Y ESTUFAS**

**RK SERIES FREESTANDING STOVES**

VISION .....	25
RK-100 .....	28
RK-80 .....	29
RK-70 .....	29
RK-60 .....	29
RK-100 Suspendido / <i>Suspended</i> .....	28
RK-80 Suspendido / <i>Suspended</i> .....	29
RK-70 Suspendido / <i>Suspended</i> .....	29
RK-60 Suspendido / <i>Suspended</i> .....	29
RK-100 Leñera / <i>With log box</i> .....	28
RK-80 Leñera / <i>With log box</i> .....	29
RK-70 Leñera / <i>With log box</i> .....	29
RK-60 Leñera / <i>With log box</i> .....	29
RK-100 Doble Cara / <i>DOUBLE-SIDED</i> ....	30
RK-80 Doble Cara / <i>DOUBLE-SIDED</i> ....	30
RA-100-2 Suspendido / <i>Suspended</i> .....	32
RA-85-2 Leñera / <i>With log box</i> .....	33
RA-85-2 Sobre pie / <i>Free-standing</i> .....	33
ARES-2 .....	34
MAIA ROUND .....	36
MAIA LARGE .....	37
MAIA WALL .....	37
MAIA CUBE .....	38
MAIA SLIM .....	38

**ESTUFAS CON HORNO**

**STOVES WITH OVEN**

ATLAS Insertable / <i>Inset</i> .....	39
ATLAS .....	40
ZEUS .....	42
HERMES .....	44

# LA OFERTA EN INSERTABLES Y HOGARES MÁS COMPLETA

## A COMPLETE OFFER IN INSETS AND FIREPLACES



### SERIE I

#### La referencia en casetes insertables *The inset's reference*

- Ideales para la renovación de una vieja chimenea o para obra nueva.
- Rendimientos entre el 81% y el 87%.
- Disponibles en tamaños de 60, 70, 80 y 100 cm
- Incluyen sistema de ventilación mediante ventiladores metálicos axiales.
- Permiten la canalización de aire caliente.
- Incluyen cajón cenicero (excepto I-60).
- Entrada de aire exterior opcional para la combustión.
- Amplia variedad de marcos a elegir.
- Tres opciones para el revestimiento de la cámara de combustión.

- *Ideal to renew existing fireplaces or for new installations.*
- *Efficiency between 81% and 87%.*
- *Available in widths of 60, 70, 80 and 100 cm.*
- *Axial fans included.*
- *Possibility to channel hot air to other rooms.*
- *Ash pan included (except I-60).*
- *Optional external air intake.*
- *A broad range of frames to choose.*
- *Three options for the interior lining.*



### SERIE KRONOS

Doble cara / Double-sided

#### Modelos de doble cara *Double-sided units*

- Disponibles en tamaños de 70, 80 y 100 cm
- Rendimientos superiores al 79%
- Incluyen sistema de ventilación mediante 4 ventiladores metálicos axiales.
- Permiten la canalización de aire caliente.
- Incluyen cajón cenicero
- Entrada de aire exterior opcional para la combustión.
- Amplia variedad de marcos a elegir.

- *Available in 70, 80 or 100 cm.*
- *Efficiency more than 79%.*
- *4 axial fans included.*
- *Possibility to channel hot air to other rooms.*
- *Include ash pan.*
- *Optional external air intake for combustion.*
- *A broad range of frames to choose from.*



## SERIE T-2

### Hogares panorámicos *Panoramic fireplaces*

- Ideales para obra nueva.
  - Disponibles en tamaños de 70, 80 y 100 cm.
  - No incluyen ventilación de serie.
  - Cristal panorámico.
  - Entrada de aire exterior opcional para la combustión.
  - Ventilación opcional mediante potente y silenciosa turbina con opción de centralita y mando a distancia.
  - Permite la canalización de aire caliente a otras habitaciones a mayor distancia.
  - Amplia variedad de marcos a elegir.
  - Entrada de aire para convección.
- 
- *The best option for new installations .*
  - *Available in widths of 70, 80 or 100 cm.*
  - *Without fans.*
  - *Panoramic glass.*
  - *Optional ventilation system with a powerful and silent turbine with control remote.*
  - *Possibility to channel hot air to other rooms.*
  - *A broad range of frames to choose from.*
  - *Convection air entry.*



## MODELO HK

### Idóneo para obra nueva *Ideal for new installations*

- Versión de doble cara de 100 cm.
  - Ventilación opcional mediante potente y silenciosa turbina con opción de centralita y mando a distancia.
  - Permite la canalización de aire caliente a otras habitaciones a mayor distancia.
  - Marcos estrechos para un acabado minimalista.
  - Entrada de aire exterior opcional para la combustión.
  - Entrada de aire para convección.
- 
- *100 cm double-side unit.*
  - *Optional ventilation system consisting of a powerful and silent turbine with control remote.*
  - *Possibility to channel hot air to other rooms.*
  - *Narrow frames for a minimalist finish.*
  - *Optional exterior air intake.*
  - *Convection air entry.*



# PERSONALICE SU PROPIO CASSETTE INSERTABLE CUSTOMIZE YOUR OWN INSET

## PERSONALICE EL REVESTIMIENTO INTERIOR CUSTOMIZE THE INTERIOR LINING OF YOUR INSET



Rendimiento Performance	Resistencia Strength	Respuesta térmica Thermal response
★★★★★	★★★★★	★★★★★

### THERMIC

Interior revestido con placas refractarias. Muy resistente y con una elevada inercia térmica. Material autolimpiante.

*Interior lined with refractory slabs. High strength. High level of thermal inertia. Self-cleaning material.*



Rendimiento Performance	Resistencia Strength	Respuesta térmica Thermal response
★★★★★	★★★☆☆	★★★★★

### VERMICULITA / VERMICULITE

Interior revestido con placas de Vermiculita. Gracias a sus propiedades refractarias se consiguen temperaturas más elevadas, favoreciendo la combustión de la leña.

*Interior lined with Vermiculite sheets. Their refractory properties offer higher temperatures, improving the combustion.*



Rendimiento Performance	Resistencia Strength	Respuesta térmica Thermal response
★★★★★	★★★★★	★★★★★

### ECO

Interior revestido con paneles de acero. Proporcionan una respuesta al calor rápida y potente. El pliegue de la superficie de los paneles le confiere una gran resistencia a tensiones y deformaciones.

*Interior lined with steel sheets, which provide response a rapid to the heat. These sheets provides a high level of resistance to stress and deformations.*

## PERSONALICE LAS DIMENSIONES Y ESTILOS DEL MARCO CUSTOMIZE THE FRAME SIZE AND STYLE



Marco Passepartout, 0,3 cm.  
Passepartout frame, 0,3 cm.



Marco 4 lados, 2,5 cm.  
4-sided frame, 2,5 cm.



Marco 3 lados, 4,5 cm.  
3-sided frame, 4,5 cm.



Marco 4 lados, 4,5 cm.  
4-sided frame, 4,5 cm.



Marco CRISTAL  
GLASS frame





## POR UN MEDIOAMBIENTE MEJOR, SOLO EQUIPOS ECODESIGN

El 1 de enero 2022 entra en vigor en toda Europa la **normativa de obligatorio cumplimiento Ecodesign**, una nueva regulación, que obliga a los fabricantes y vendedores de equipos de combustibles sólidos a comercializar e instalar solo productos que cumplan con sus criterios:

- Rendimientos energéticos mayores.
- Niveles de emisiones más bajos.

### ¿Qué beneficios tiene esta norma para el consumidor?

- Mayor ahorro en combustible.
- Respeto por el medio ambiente.
- Mejora y protección de la calidad del aire.

### ¿Cómo reconozco un producto Ecodesign?

El compromiso de **Carbel** con el medio ambiente es ofrecer todo un catálogo de productos acorde a la normativa, podrás distinguirlos gracias a su sello:

## FOR A BETTER ENVIRONMENT, ONLY ECODESIGN DEVICES

*The 1<sup>st</sup> of January 2022 will enter into force throughout Europe the **new mandatory regulation Ecodesign**, a new regulation that obliges manufacturers and sellers of solid fuel equipment to market and install only products that meet their criteria:*

- *Higher energy efficiencies.*
- *Lower levels of emissions.*

### *What benefits does EcoDesign have for the consumer?*

- *Lower consumption of wood.*
- *Respect for the environment.*
- *Air quality protection and improvement.*

### *How do I recognize an Ecodesign product?*

*Carbel's commitment to the environment is to offer a whole catalogue of products in accordance with the regulations. You can distinguish them thanks to the seal:*



Por el futuro de todos, exige productos Ecodesign.  
*For the future of all, demand Ecodesign products.*

# I-100

## La gama de insertables con más prestaciones *The range of cassettes with outstanding performances*

- Sistema de regulación de la salida de aire caliente frontal.
  - Entrada de aire exterior opcional para la combustión.
  - Sistema de ventiladores con interruptor de dos velocidades y termostato de seguridad.
  - Incluye cajón cenicero.
  - Puerta reversible y reforzada.
- *Front air outlet adjustment system.*
  - *Optional exterior air intake.*
  - *Ventilation through two-speed fans and safety thermostat.*
  - *Ash pan included.*
  - *Reversible door.*



### I-100

- Rendimiento 87,3%.
  - Dispone de 4 ventiladores y 4 salidas para la canalización del aire caliente.
  - Gran cámara de combustión en Vermiculita, Eco o Thermic.
- *Efficiency rate of 87,3%.*
  - *Equipped with 4 fans and 4 outlets for channelling hot air.*
  - *Large combustion chamber available in Vermiculite, Eco or Thermic.*

A+



# I-80

## La gama de insertables con más prestaciones *The range of cassettes with outstanding performances*

- Sistema de regulación de la salida de aire caliente frontal.
  - Entrada de aire exterior opcional para la combustión.
  - Sistema de ventiladores con interruptor de dos velocidades y termostato de seguridad.
  - Incluye cajón cenicero.
  - Puerta reversible y reforzada.
- *Front air outlet adjustment system.*
  - *Optional exterior air intake.*
  - *Ventilation through two-speed fans and safety thermostat.*
  - *Ash pan included.*
  - *Reversible door.*



### I-80

- Rendimiento 85,09%.
  - Dispone de 2 ventiladores y 4 salidas para la canalización del aire caliente.
  - Gran cámara de combustión en Vermiculita, Eco o Thermic.
- *Efficiency rate of 85,09%.*
  - *Includes 2 fans and 4 outlets for channelling hot air.*
  - *Large combustion chamber available in Vermiculite, Eco or Thermic.*

A+





# I-70

## La gama de insertables con más prestaciones *The range of cassettes with outstanding performances*

- Sistema de regulación de la salida de aire caliente frontal.
  - Entrada de aire exterior opcional para la combustión.
  - Sistema de ventiladores con interruptor de dos velocidades y termostato de seguridad.
  - Incluye cajón cenicero.
  - Puerta reversible y reforzada.
- *Front air outlet adjustment system.*
  - *Optional exterior air intake.*
  - *Ventilation through two-speed fans and safety thermostat.*
  - *Ash pan included.*
  - *Reversible door.*



### I-70

- Rendimiento 85,09%.
  - Dispone de 2 ventiladores y 2 salidas para la canalización del aire caliente.
  - Gran cámara de combustión en Vermiculita, Eco o Thermic.
- *Efficiency rate of 85,09%.*
  - *Includes 2 fans and 2 outlets for channelling hot air.*
  - *Large combustion chamber available in Vermiculite, Eco or Thermic.*

A+



# I-60

## La gama de insertables con más prestaciones *The range of cassettes with outstanding performances*

- Sistema de regulación de la salida de aire caliente frontal.
  - Entrada de aire exterior opcional para la combustión.
  - Sistema de ventiladores con interruptor de dos velocidades y termostato de seguridad.
  - Puerta reversible y reforzada.
- *Front air outlet adjustment system.*
  - *Optional exterior air intake.*
  - *Ventilation through two-speed fans and safety thermostat.*
  - *Reversible door.*



### I-60

- Rendimiento 81%.
  - Dispone de 2 ventiladores y 2 salidas para la canalización del aire caliente.
  - Gran cámara de combustión en Vermiculita o Thermic.
- *Efficiency rate of 81%.*
  - *Includes 2 fans and 2 outlets for channelling hot air.*
  - *Large combustion chamber available in Vermiculite or Thermic.*

A+





INSERTABLE / INSET

# KRONOS DOBLE CARA / DOUBLE-SIDED

## Incomparable visión del fuego *Unmatched views of the fire*

- Disponible en tamaños de 100, 80, y 70 cm.
  - Sistema de ventilación por ambos lados mediante 4 ventiladores.
  - Entrada de aire exterior opcional para la combustión.
  - Sistema de regulación de la salida de aire caliente frontal.
- Available in widths of 100, 80 or 70 cm.
  - Ventilation system at both sides, with 4 fans.
  - Optional exterior air intake.
  - Front air outlet adjustment system.



### KRONOS 100 DOBLE CARA / DOUBLE-SIDED

- Rendimiento 79%.
  - Dispone de 4 ventiladores y 2 salidas para la canalización del aire caliente.
  - Cámara de combustión en Vermiculita.
- Efficiency rate of 79%.
  - Includes 4 fans and 2 outlets for channelling hot air.
  - Interior lining in Vermiculite.

A







**KRONOS 80 DOBLE CARA / DOUBLE-SIDED**

- Rendimiento 79%.
- Dispone de 4 ventiladores y 2 salidas para la canalización del aire caliente.
- Cámara de combustión en Vermiculita.
- *Efficiency rate of 79%.*
- *Includes 4 fans and 2 outlets for channelling hot air.*
- *Interior lining in Vermiculite.*



**KRONOS 70 DOBLE CARA / DOUBLE-SIDED**

- Rendimiento 82%.
- Dispone de 4 ventiladores y 2 salidas para la canalización del aire caliente.
- Cámara de combustión en Vermiculita.
- *Efficiency rate of 82%.*
- *Includes 4 fans and 2 outlets for channelling hot air.*
- *Interior lining in Vermiculite.*



## Características y opciones de personalización *Features and customization options*

### OPCIONES DE REVESTIMIENTO PARA LA CÁMARA DE COMBUSTIÓN *CUSTOMIZE THE INTERIOR LINING OF YOUR FIREPLACE*



#### **THERMIC**

Interior revestido con placas refractarias. Muy resistente y con una elevada inercia térmica. Material autolimpiante.

*Interior lined with refractory slabs. High strength. High level of thermal inertia. Self-cleaning material.*

Excepto modelos de doble cara.  
*Except double-sided models.*



#### **VERMICULITA / VERMICULITE**

Interior revestido con placas de Vermiculita. Gracias a sus propiedades refractarias se consiguen temperaturas más elevadas, favoreciendo la combustión de la leña.

*Interior lined with Vermiculite sheets. Their refractory properties offer higher temperatures, improving the combustion.*



#### **ECO**

Interior revestido con paneles de acero. Proporcionan una respuesta al calor rápida y potente. El pliegue de la superficie de los paneles le confiere una gran resistencia a tensiones y deformaciones.

*Interior lined with steel sheets, which provide response a rapid to the heat. These sheets provides a high level of resistance to stress and deformations.*

Excepto I-60 y modelos de doble cara.  
*Except I-60 and double-sided models.*

### EL CUIDADO DE LOS DETALLES MARCA LA DIFERENCIA *THE DETAILS MAKE THE DIFFERENCE*



Cristales serigrafiados que realzan el diseño del producto. Líneas modernas, sencillas y estilizadas. Calidad en los materiales y en la concepción del producto.

*Screen printed glass makes the design of the product stand out. Modern, simple and stylish lines. Quality, both of the materials and the concept of the product.*



#### **Clapeta frontal de regulación de aire**

Regulación frontal que permite abrir o cerrar la salida de aire, permitiendo redirigir mayor calor a las habitaciones en caso de que se canalice.

#### **Frontal flap for air regulation**

Frontal regulation for opening and closing the convection air outlet, allowing more air to be channelled to other rooms.



#### **Máximo control en la combustión**

Entrada de aire primario regulable para controlar el encendido. Entrada de aire secundario para controlar la combustión y el consumo de leña.

#### **Maximum control of the combustion**

*Adjustable primary air to control the lighting of the fire. Adjustable secondary air to control the combustion and the volume of firewood consumption.*

## Características y opciones de personalización *Features and customization options*

### OPCIONES DE MARCO FRAME OPTIONS

Marco CRISTAL  
*GLASS frame*

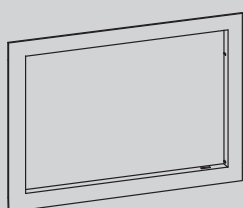

**MODELOS / MODELS**

I-100 / T-100-2  
I-80 / T-80-2  
I-70 / T-70-2  
K-100 Doble cara / *Double-sided*  
K- 80 Doble cara / *Double-sided*  
K- 70 Doble cara / *Double-sided*

Marco Passepartout  
*Passepartout frame*

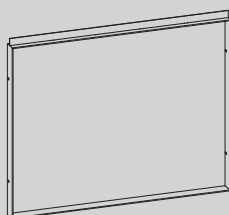

**MODELOS / MODELS**

I-100 / T-100-2  
I-80 / T-80-2  
I-70 / T-70-2  
K-100 Doble cara / *Double-sided*  
K- 80 Doble cara / *Double-sided*  
K- 70 Doble cara / *Double-sided*

Marco 3 lados, 4,5 cm.  
*3 sided frame, 4,5 cm.*

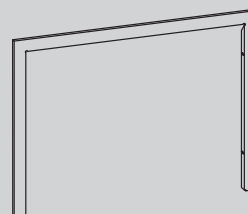

**MODELOS / MODELS**

I-100 / T-100-2  
I-80 / T-80-2  
I-70 / T-70-2  
I-60  
K-100 Doble cara / *Double-sided*  
K- 80 Doble cara / *Double-sided*  
K- 70 Doble cara / *Double-sided*

Marco 4 lados, 2,5 cm.  
*4 sided frame, 2,5 cm.*

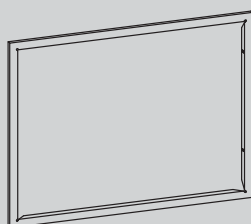

**MODELOS / MODELS**

I-100 / T-100-2  
I-80 / T-80-2  
I-70 / T-70-2  
I-60  
K-100 Doble cara / *Double-sided*  
K- 80 Doble cara / *Double-sided*  
K- 70 Doble cara / *Double-sided*

Marco 4 lados, 4,5 cm.  
*4 sided frame, 4,5 cm.*

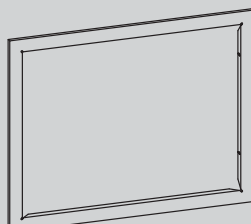

**MODELOS / MODELS**

I-100 / T-100-2  
I-80 / T-80-2  
I-70 / T-70-2  
I-60  
K-100 Doble cara / *Double-sided*  
K- 80 Doble cara / *Double-sided*  
K- 70 Doble cara / *Double-sided*

Marco especial 9 cm.  
*Wide frame 9 cm.*

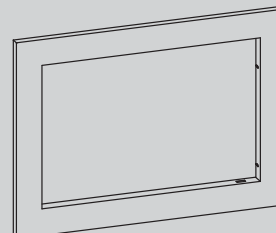

**MODELOS / MODELS**

K-100 Doble cara / *Double-sided*  
K- 80 Doble cara / *Double-sided*  
K- 70 Doble cara / *Double-sided*



# T-100-2

## La gama de hogares más panorámicos *Range of panoramic fireplaces*

- Disponibles en tamaños de 100, 80, y 70 cm.
  - Entrada de aire exterior para la combustión.
  - Sin ventilación de serie.
  - Opcional turbina eco silent con centralita y mando a distancia o Box 430.
  - Puerta reversible y reforzada.
- Available in widths of 100, 80 or 70 cm.
  - Exterior air intake.
  - Without ventilation as standard.
  - Optional Ecosilent turbine with control unit and remote control or Box 430.
  - Reversible door.



**NUEVO DISEÑO**

Opcional turbina Eco Silent con centralita y mando a distancia  
*Optional Eco Silent turbine with control module and remote*



Opción de marcos personalizables.  
*Optional customizable frames.*

### T-100-2

- Rendimiento 87,3%.
  - Ideal para canalizar a otras habitaciones.
  - Gran cámara de combustión en Vermiculita.
- Efficiency rate of 87,3%.
  - The best option to channel the air to others rooms.
  - Interior lining in Vermiculite.

A+



# T-80-2

## La gama T ofrece las mejores prestaciones y rendimientos *The T range offers the best performance and efficiency*

- Disponibles en tamaños de 100, 80, y 70 cm.
  - Entrada de aire exterior para la combustión.
  - Sin ventilación de serie.
  - Opcional turbina eco silent con centralita y mando a distancia o Box 430.
  - Puerta reversible.
- Available in widths of 100, 80 or 70 cm.
  - Exterior air intake.
  - Without ventilation as standard.
  - Optional Ecosilent turbine with control unit and remote control or Box 430.
  - Reversible door.



### T-80-2

- Rendimiento 85,09%.
  - Ideal para canalizar a otras habitaciones.
  - Gran cámara de combustión en Vermiculita.
- Efficiency rate of 85,09%.
  - The best option to channel the air to others rooms.
  - Interior lining in Vermiculite.

A+



# T-70-2

## Gran cámara de combustión y cristal panorámico *Large combustion chamber and panoramic glass*

- Disponibles en tamaños de 100, 80, y 70 cm.
  - Entrada de aire exterior para la combustión.
  - Sin ventilación de serie.
  - Opcional turbina eco silent con centralita y mando a distancia o Box 430.
  - Puerta reversible.
- Available in widths of 100, 80 or 70 cm.
  - Exterior air intake.
  - Without ventilation as standard.
  - Optional Ecosilent turbine with control unit and remote control or Box 430.
  - Reversible door.



### T-70-2

- Rendimiento 85,09%.
  - Ideal para canalizar a otras habitaciones.
  - Gran cámara de combustión en Vermiculita.
- Efficiency rate of 85,09%.
  - The best option to channel the air to others rooms.
  - Interior lining in Vermiculite.

A+





GAMA T-2  
T-2 RANGE

## Características y opciones de personalización *Features and customization options*

### CÁMARA DE COMBUSTIÓN / INTERIOR LINING



Cámara de combustión revestida de Vermiculita  
*Vermiculite lined combustion chamber*

### OPCIONES DE VENTILACIÓN GAMA T-2 T-2 RANGE VENTILATION OPTIONS

**1** - Convección natural (sin turbina).  
*Natural convection (without fans).*



**2** - Turbina ECO SILENT con centralita y mando a distancia.  
*ECO SILENT turbine with control module and remote control.*



**3** - Box ECO SILENT con centralita y mando a distancia.  
*ECO SILENT box with control module and remote control.*

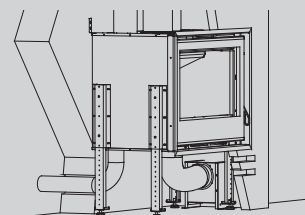

OPCIONAL - Kit de patas y escuadras.  
*OPTIONAL - Set of legs and adjustable fasteners.*

### OPCIONES DE MARCO FRAME OPTIONS

Passepartout  
*Passepartout*

3 lados, 4,5 cm.  
*3 sided, 4,5 cm.*

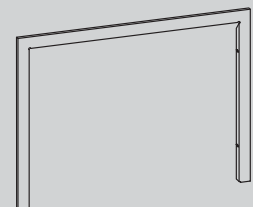
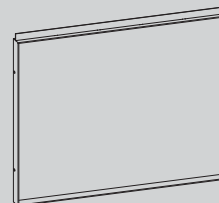

4 lados, 4,5 cm.  
*4 sided, 4,5 cm.*

4 lados, 2,5 cm.  
*4 sided, 2,5 cm.*

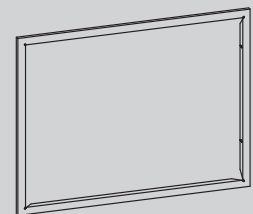
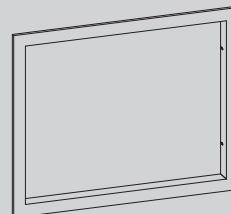

Marco CRISTAL  
*GLASS frame*

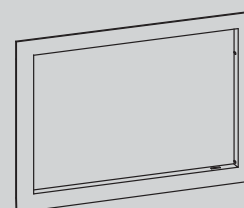

# HK-100 DOBLE CARA / DOUBLE-SIDED

De estilo actual, con una inmejorable visión del fuego  
*Contemporary style with an unbeatable view of the fire*

- Gran cámara de combustión.
  - Entrada de aire exterior opcional para la combustión.
  - Entrada de aire para la convección.
  - Sistema de regulación de la salida de aire caliente frontal.
  - Dispone de 4 salidas para la canalización del aire caliente.
- *Large combustion chamber.*
  - *Optional exterior air intake.*
  - *Convection air intake.*
  - *Front air outlet adjustment system.*
  - *Includes 4 outlets for channelling hot air.*



## HK-100 DOBLE CARA / DOUBLE-SIDED

- Rendimiento 79%.
  - Turbina opcional de 430 m<sup>3</sup>/h., con regulador de velocidad.
  - Turbina opcional Eco silent, potente y muy silenciosa.
  - Cámara de combustión en Vermiculita.
- *Efficiency rate of 79%.*
  - *Optional 430 m<sup>3</sup>/h. turbine fan, with speed control.*
  - *Optional Eco silent turbine, powerful and very silent.*
  - *Interior lining in Vermiculite.*

A



GAMA HOGARES  
FIREPLACES

## Características y opciones de personalización *Features and customization options*

### CÁMARA DE COMBUSTIÓN *INTERIOR LINING*



Cámara de combustión revestida de Vermiculita  
*Vermiculite lined combustion chamber*

### OPCIONES DE VENTILACIÓN HK-100 DC / *HK-100 DC VENTILATION OPTIONS*



Turbina Eco Silent con centralita y mando a distancia. Potente y muy silenciosa.  
*Eco Silent turbine with control module and remote control. Powerfull and very silent.*



Turbina con regulador  
*Turbine with regulator*

### OPCIONES DE MARCO / *FRAME OPTIONS*

Passepartout  
*Passepartout*

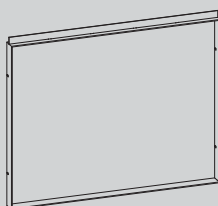

**MODELOS / MODELS**  
HK-100 Doble cara / *Double-sided*

4 lados, 4,5 cm.  
*4 sided, 4,5 cm.*

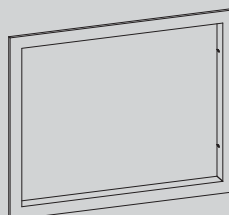

**MODELOS / MODELS**  
HK-100 Doble cara / *Double-sided*

4 lados, 1,5 cm. y 10 cm. de profundidad  
*4 sided, 1,5 cm. and 10 cm. deep*

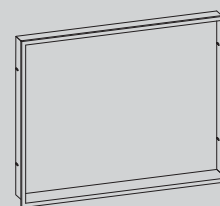

**MODELOS / MODELS**  
HK-100 Doble cara / *Double-sided*



INSERTABLE / INSET

# A-100-2, A-85-2 y A-70-2

## Insertables con visión lateral a dos o tres cristales *A range of inserts two or three side glasses*

- Disponible en tamaños de 100, 85, y 70 cm.
- Ideales para crear dos o tres ambientes gracias a su visión lateral.
- Disponen de 2 salidas para la canalización del aire caliente.
- Entrada de aire exterior opcional para la combustión.
- Puerta reversible, posibilidad de apertura a derecha o izquierda.
- Available in widths of 100, 85 or 70 cm.
- The best option to create warmth areas.
- Includes 2 outlets for channelling hot air.
- Optional exterior air intake.
- Reversible door, possibility to have the opening on the right or on the left.



### A-100-2

- Rendimiento 78%.
- Ventilación de 720 m<sup>3</sup>/h. mediante cuatro ventiladores de dos velocidades y termostato de seguridad.
- Cámara de combustión de Thermic.
- Efficiency rate of 78%.
- 720 m<sup>3</sup>/h ventilation by means of four 2-speed fans and safety thermostat.
- Interior lining in Thermic.

A+





**A-85-2 / A-70-2**

- Rendimiento 75%.
- Ventilación de 360 m<sup>3</sup>/h. mediante dos ventiladores de dos velocidades y termostato de seguridad.
- Cámara de combustión de Thermic.

- Efficiency rate of 75%.
- 360 m<sup>3</sup>/h ventilation by means of four 2-speed fans and safety thermostat.
- Interior lining in Thermic.

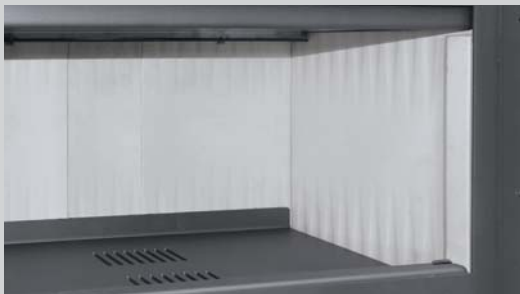

**CÁMARA DE COMBUSTIÓN DE THERMIC  
COMBUSTION CHAMBER IN THERMIC**

Interior revestido con placas refractarias. Muy resistente y con una elevada inercia térmica. Material autolimpiante.

*Interior lined with refractory slabs. High strength. High level of thermal inertia. Self-cleaning material.*

**OPCIONES DE MARCO  
FRAME OPTIONS**

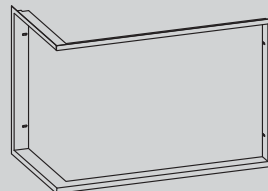

- Marco 4 lados, 2,5 cm. Para cristal a dos caras, a derecha o izquierda
- 4 sided, 2,5 cm. frame. For two glasses, right or left

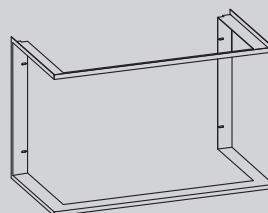

- Marco 4 lados, 2,5 cm. Para cristal a tres caras
- 4 sided, 2,5 cm. frame. For three sides glasses

# VISION

## Moderno y minimalista *Modern and minimalist*

- Hogar de diseño vertical y máxima visión gracias a su puerta completamente acristalada.
- Modelo estanco con posibilidad de toma de aire exterior para la combustión.
- Entrada de aire para la convección.
- *A portrait insert with a fully glazed door that fills the window with fire.*
- *An airtight model that can draw all its combustion air from outside.*
- *Convection air intake.*



### VISION INSERTABLE / INSERT

- Rendimiento 80%.
- Dispone de 2 salidas para la canalización del aire caliente.
- Cámara de combustión en Vermiculita.
- *Efficiency rate of 80%.*
- *Includes 2 outlets for channelling hot air.*
- *Interior lining in Vermiculite.*

A+







VISION SUSPENDIDA / SUSPENDED



VISION



VISION SOBRE PIE / FREE-STANDING



VISION STAND



Cámara de combustión de Vermiculita. Máxima visión del fuego gracias a su gran puerta completamente acristalada.

*Combustion chamber in Vermiculite. Maximum view of the fire, thanks to its large, completely glazed door.*



**BOX 180**

Sistema para impulsar el aire caliente de convección gracias a su silencioso ventilador de 180 m<sup>3</sup>. Apto para VISION insertable.

**BOX 180**

*A system that directs convection-heated air by means of a quiet 180 m<sup>3</sup> fan. Suitable for VISION insertable.*

# G-100

## Modelo guillotina, tecnología y diseño *Model with lift-up door, technology and design*

- Hogar panorámico de 100 cm. con puerta guillotina.
- Opcional Box Eco silent, potente y muy silenciosa con centralita y mando a distancia.
- Entrada de aire exterior para la combustión.
- Entrada de aire para la convección.
- *Panoramic one meter wide insert stove with a lifting door.*
- *Optional Eco silent Box, powerful and very silent with control module and remote control.*
- *Exterior air inlet for combustion air.*
- *Convection air outlets.*



### G-100

- Rendimiento 76%.
- Dispone de 4 salidas para la canalización del aire caliente.
- Cámara de combustión de Thermic.
- *Efficiency rate of 76%.*
- *Includes 4 outlets for channelling hot air.*
- *Interior lining in Thermic.*

A



G-100

## Características y opciones *Features and options*



Puerta deslizable y abatible. Amplio cristal serigrafiado.

*Sliding and hinged door. Wide screen printed window.*



Puerta de apertura lateral. Facilita la limpieza del cristal.

*Hinged door opening sideways. Allows the cleaning of the glass.*



Cámara de combustión de THERMIC. Mayor inercia térmica y resistencia.

*Combustion chamber in THERMIC. High level of thermal inertia and strength.*



Monomando. Permite controlar el aire de combustión primario y secundario.

*Single control. Allows control of primary and secondary combustion air.*



Dispone de toma de aire de combustión canalizable del exterior. De manera independiente otra toma de aire permite la entrada del aire de convección.

*Equipped with an exterior air inlet for combustion air. A different inlet allows the entrance of convection air.*

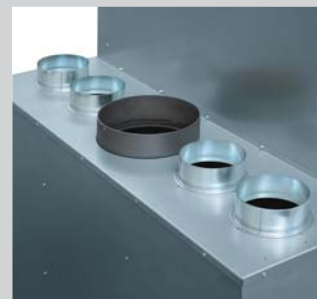

Canalizable. Dotado de 4 salidas para canalizar el aire caliente.

*Prepared for hot air ducts. 4 outlets for the channelling of hot air to other rooms.*



### **BOX ECO SILENT CON CENTRALITA Y MANDO A DISTANCIA**

Opcional sistema de ventilación independiente potente y silencioso.

### **ECO SILENT BOX WITH CONTROL MODULE AND REMOTE CONTROL**

*Optional fan system, powerful and silent.*



# RK

## Listos para instalar *Ready to install*

- Disponibles en tamaños de 100, 80, 70 y 60 cm.
- Su diseño le permitirá disfrutar del calor por radiación, mientras que sus ventiladores integrados acelerarán la aportación de calor por convección.
- Gran cámara de combustión.
- Entrada de aire exterior opcional para la combustión.
- Available in widths of 100, 80, 70 or 60 cm.
- The design will allow you to enjoy the radiant heat as well as the additional convection warmth from its installed fans.
- Large combustion chamber.
- Optional exterior air intake.



### RK-100 (Opción suspendido a la pared / Wall-suspended option)

- Rendimiento 78%.
- Dispone de 4 ventiladores.
- Cámara de combustión en Vermiculita o Thermic.
- Disponible para los modelos RK-100, RK-80, RK-70 y RK-60.
- Efficiency rate of 78%.
- Equipped with 4 fans.
- Combustion chamber available in Vermiculite or Thermic.
- Available for models RK-100, RK-80, RK-70 and RK-60.

A





**RK-80** (Opción sobre leñera / *Supported on log store*)

- Rendimiento 78,5%.
  - Dispone de 3 ventiladores.
  - Cámara de combustión en Vermiculita o Thermic.
  - Disponible para los modelos RK-100, RK-80, RK-70 y RK-60.
- Efficiency rate of 78,5%.
  - Equipped with 3 fans.
  - Combustion chamber available in Vermiculite or Thermic.
  - Available for models RK-100, RK-80, RK-70 and RK-60.



**RK-70** (Opción sobre pie / *Free-standing*)

- Rendimiento 79%.
  - Dispone de 2 ventiladores.
  - Cámara de combustión en Vermiculita o Thermic.
  - Disponible para los modelos RK-100, RK-80 y RK-70.
- Efficiency rate of 79%.
  - Equipped with 2 fans.
  - Combustion chamber available in Vermiculite or Thermic.
  - Available for models RK-100, RK-80 and RK-70.



**RK-60** (Opción sobre bancada / *Supported on pedestal*)

- Rendimiento 81%.
  - Dispone de 2 ventiladores.
  - Cámara de combustión en Vermiculita o Thermic.
  - Disponible para los modelos RK-100, RK-80, RK-70 y RK-60.
- Efficiency rate of 81%.
  - Equipped with 2 fans.
  - Combustion chamber available in Vermiculite or Thermic.
  - Available for models RK-100, RK-80, RK-70 and RK-60.



## RK DOBLE CARA / DOUBLE-SIDED

Disfruta el doble de la visión del fuego  
*Enjoy twice the vision of fire*

- Disponible en tamaños de 100 y 80 cm.
- Diseños a doble cara, ideales para separar ambientes y disfrutar del espectáculo del fuego.
- Sistema de ventilación por ambos lados mediante cuatro ventiladores.
- Available in widths of 100 or 80 cm.
- DOUBLE-SIDED design, ideal for separating different areas, and enjoying the fire from both.
- Ventilation system on both sides by means of four fans.



### RK-100, RK-80 DOBLE CARA / DOUBLE-SIDED

- Rendimiento 79%.
- Sistema de ventilación por ambos lados mediante cuatro ventiladores.
- Cámara de combustión en Vermiculita.
- Efficiency rate of 79%.
- Ventilation system on both sides through.
- Interior lining in Vermiculite.





SERIE RK  
RK SERIES

## Características y opciones de personalización *Features and customization options*

### OPCIONES DE INTERIOR / INTERIOR OPTIONS



#### VERMICULITA / VERMICULITE

Interior revestido con placas de Vermiculita. Gracias a sus propiedades refractarias se consiguen temperaturas más elevadas, favoreciendo la combustión de la leña.

*Interior lined with Vermiculite sheets. Their refractory properties offer higher temperatures, improving the combustion.*



#### THERMIC

Interior revestido con placas refractarias. Muy resistente y con una elevada inercia térmica. Material autolimpiante. (Opcional para versiones de una cara: RK-100, RK-80, RK-70 y RK-60)

*Interior lined with refractory slabs. High strength. High level of thermal inertia. Self-cleaning material. (Optional for one-sided versions: RK-100, RK-80, RK-70 and RK-60)*

### OPCIONES PERSONALIZACIÓN / CUSTOMIZATION OPTIONS

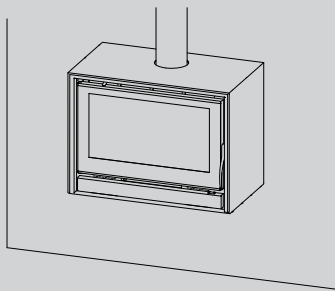

Suspendido a la pared  
*Wall-suspended*

RK-100  
RK-80  
RK-70  
RK-60

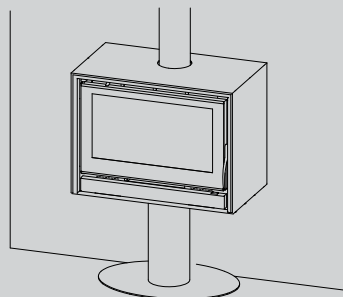

Sobre pie  
*Free-standing*

RK-100  
RK-80  
RK-70  
RK-100 Doble cara/  
*Double-sided*  
RK-80 Doble cara/  
*Double-sided*

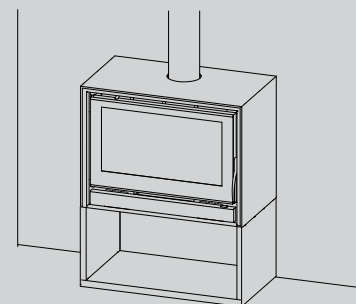

Sobre leñera  
*Supported on log store*

RK-100  
RK-80  
RK-70  
RK-60

# RA-100-2 y RA-85-2

## Estufas a tres cristales *Stove with three-sided glasses*

- Disfrutará al máximo gracias a su visión del fuego a través de sus tres caras acristaladas.
  - Su diseño tipo estufa le permitirá simplificar la instalación.
  - Múltiples opciones de montaje.
  - Puerta reversible, posibilidad de apertura a derecha o izquierda.
- *The best way to enjoy the fire.*
  - *For an easy installation.*
  - *Multiple installation options.*
  - *Reversible door, possibility to have the opening on the right or on the left.*

**NOVEDAD**



Nuevo maneta cromada y cantonera negra.  
*New chromed handle and black corners.*

### RA-100-2 (Opción suspendido a la pared / Wall-suspended)

- Rendimiento 78%.
  - Ventilación de 720 m<sup>3</sup>/h. mediante cuatro ventiladores de dos velocidades y termostato de seguridad.
  - Cámara de combustión de Thermic.
- *Efficiency rate of 78%.*
  - *720 m<sup>3</sup>/h ventilation by means of four 2-speed fans and safety thermostat.*
  - *Interior lining in Thermic.*

**A**





**RA-85-2 (Opción sobre pie / Free-standing)**

- Rendimiento 75%.
- Ventilación de 360 m<sup>3</sup>/h. mediante dos ventiladores de dos velocidades y termostato de seguridad.
- Cámara de combustión de Thermic.

- Efficiency rate of 75%.
- 360 m<sup>3</sup>/h ventilation by means of two 2-speed fans and safety thermostat.
- Interior lining in Thermic.



**RA-85-2 (Opción sobre leñera / Supported on log store)**

- Rendimiento 75%.
- Ventilación de 360 m<sup>3</sup>/h. mediante dos ventiladores de dos velocidades y termostato de seguridad.
- Cámara de combustión de Thermic.

- Efficiency rate of 75%.
- 360 m<sup>3</sup>/h ventilation by means of two 2-speed fans and safety thermostat.
- Interior lining in Thermic.



**CÁMARA DE CONBUSTIÓN DE THERMIC  
COMBUSTION CHAMBER IN THERMIC**

Interior revestido con placas refractarias. Muy resistente y con una elevada inercia térmica. Material autolimpiante.

*Interior lined with refractory slabs. High strength. High level of thermal inertia. Self-cleaning material.*



# ARES-2

## La estufa eficiente *The highly efficient stove*

- Rendimiento mejorado.
- Cristal panorámico para una inmejorable visión de fuego.
- Amplia cámara de combustión con un ancho útil de más de 50 cm.
- Entrada de aire exterior opcional para la combustión.
- Mayor cámara de combustión.
- *Improved efficiency.*
- *Panoramic glass that offers an unbeatable view of the fire.*
- *Large combustion chamber, with a useable width of over 50 cm.*
- *Optional exterior air intake.*
- *Larger combustion chamber.*

**NUEVO DISEÑO**



### ARES-2

- Rendimiento 85,09%.
- Cámara de combustión de Thermic.
- Opcional tapa superior en cristal.
- *Efficiency rate of 79%.*
- *Interior lining in Thermic.*
- *Glass top option.*

A+



ARES-2

## Características y opciones de personalización *Features and customization options*



### **CÁMARA DE CONBUSTIÓN DE THERMIC COMBUSTION CHAMBER IN THERMIC**

Mayor cámara de combustión.

Interior revestido con placas refractarias. Muy resistente y con una elevada inercia térmica. Material autolimpiante.

*Larger combustion chamber*

*Interior lined with refractory slabs. High strength. High level of thermal inertia. Self-cleaning material.*



### **CRISTAL PANORÁMICO PANORAMIC GLASS**

Gran cristal panorámico para disfrutar de todo el espectáculo del fuego. Sistema cristal limpio para una visión perfecta de las llamas.

Puerta reversible.

*Large panoramic glass to enjoy all the beauty of the fire. Clean glass system for a perfect view of the flames.*

*Reversible door.*



### **REGULACIÓN AIR FLOW REGULATION**

Entradas de aire primario y secundario regulables.

*Adjustable primary and secondary air intakes.*



### **OPCIONAL TAPA SUPERIOR EN CRISTAL GLASS TOP OPTION**

Resalte el diseño de su estufa con la versión cristal. Puede elegir opcionalmente una elegante y moderna tapa de cristal vitrocerámico para decorar la parte superior de la estufa.

*Highlight the design of your stove with the glass version.*

*You can choose the option of an elegant modern ceramic glass top for decorating the upper part of your stove.*

# MAIA

## De línea esbelta y cuidada *With a fine and slim design*

- Estufa de línea esbelta y cuidada, disponible en versión ROUND, LARGE, WALL, CUBE o SLIM
- Entradas de aire primario y secundario regulables para un control total en la combustión.
- Sistema de doble deflector.
- Stove with a fine and slim design, available in ROUND, LARGE, WALL, CUBE or SLIM version.
- Primary and secondary adjustable air intakes for a complete control of the combustion.
- Double baffle system.

### Modelo con doble cámara *Double chambre unit*



Sistema de regulación de aire secundario  
*Secondary air intake adjustment*

#### MAIA ROUND

- Rendimiento 81%.
- Cámara de combustión en Vermiculita.
- Atractivo diseño redondeado.
- Dispone de un discreto leñero con puerta en la parte inferior.
- Efficiency rate of 81%.
- Interior lining in Vermiculite.
- Attractive rounded design.
- A discreet log store with door at the bottom.

A+







**Modelo con doble cámara**  
*Double chambre unit*

**MAIA LARGE**

- Rendimiento 81%.
- Cámara de combustión en Vermiculita.
- Moderna y minimalista.
- De líneas rectas destaca por su leñero abierto.

- *Efficiency rate of 81%.*
- *Interior lining in Vermiculite.*
- *Modern and minimalist.*
- *Designed on straight lines, the Maia Large stands out for its open log store.*



**Modelo con doble cámara**  
*Double chambre unit*



Patas opcionales  
*Optional feet*

**MAIA WALL** (Opcional versión suspendida o con patas / *Optional suspended or with legs version*)

- Rendimiento 81%.
- Cámara de combustión en Vermiculita.
- Opcionalmente se puede montar con un juego de patas.
- Disponible también la opción de suspender el modelo a la pared.

- *Efficiency rate of 81%.*
- *Interior lining in Vermiculite.*
- *Optionally the Maia Wall can be installed with a set of feet.*
- *Also available the option to hang this model on the wall.*





Sistema de regulación de aire secundario  
Secondary air intake adjustment

**MAIA CUBE**

- Rendimiento 81%.
- Cámara de combustión en Vermiculita.
- Moderna y minimalista.
- Diseño en vertical que mejora la combustión.

- Efficiency rate of 81%.
- Interior lining in Vermiculite.
- Modern and minimalist.
- Vertical design to boost combustion.



**MAIA SLIM**

- Rendimiento 81%.
- Cámara de combustión en Vermiculita.
- Moderna y minimalista.
- Diseño en vertical que mejora la combustión.

- Efficiency rate of 81%.
- Interior lining in Vermiculite.
- Modern and minimalist.
- Vertical design to boost combustion.



# ATLAS INSERTABLE / INSET

## Canalizable y con opción de ventiladores *Possibility of fan-driven hot air channelling*

- Modelo insertable con opción de canalizar el aire caliente a otras habitaciones. Con salida de aire por el frontal.
- Opcional marco de 4 lados.
- Cámara de combustión de Thermic.
- Entrada de aire exterior opcional para la combustión.
- Inset model that offers the option of ducting the hot air to other rooms. With front hot air outlets.
- Optional 4-sided frame.
- Interior lining in Thermic.
- Optional exterior air intake.



Incluye deflector desmontable  
antirrevoco  
*Includes removable front baffle*



### ATLAS INSERTABLE / INSET

- Rendimiento 84%.
- Opcional sistema de ventilación de 360 m<sup>3</sup>/h. mediante dos ventiladores de dos velocidades y termostato de seguridad.
- Efficiency rate of 84%.
- Optional 360 m<sup>3</sup>/h. powered fan system, with two 2-speed fans and safety thermostat.

A+





# ATLAS

## La evolución en las estufas con horno *An evolution in wood stoves with oven*

- Horno y hogar de gran capacidad.
  - Mínimas emisiones de CO del 0,03%.
  - Modelo de alto rendimiento.
  - Cámara de combustión de Thermic.
  - Entrada de aire exterior opcional para la combustión.
- *Large-capacity stove and fireplace.*
  - *Minimum CO emissions at 0,03%.*
  - *High efficiency model.*
  - *Interior lining in Thermic.*
  - *Optional exterior air intake.*



Incluye deflector desmontable  
antirrevoco  
*Includes removable front baffle*

### ATLAS

- Rendimiento 84%.
  - Opcional sistema de ventilación de 360 m<sup>3</sup>/h. mediante dos ventiladores de dos velocidades y termostato de seguridad.
- *Efficiency rate of 84%.*
  - *Optional 360 m<sup>3</sup>/h. powered fan system, with two 2-speed fans and safety thermostat.*

A+





Opcional versión rincón  
Optional corner version

**ATLAS (Versión de rincón / corner version)**

- Rendimiento 84%.
- Opcional sistema de ventilación de 360 m<sup>3</sup>/h. mediante dos ventiladores de dos velocidades y termostato de seguridad.

- Efficiency rate of 84%.
- Optional 360 m<sup>3</sup>/h. powered fan system, with two 2-speed fans and safety thermostat.



ATLAS

## Características Features



Horno superior de acero inoxidable con base de refractario y termómetro.

*Upper stainless steel oven with refractory base and thermometer.*



Incorpora un práctico registro para la limpieza de la cámara superior del horno.

*Includes a practical opening for cleaning the upper chamber of the oven.*



Cámara de combustión muy espaciosa, revestida en acero y THERMIC para mejorar el funcionamiento y el rendimiento energético.

*Very spacious combustion chamber lined with steel and THERMIC for improved operation and energy performance.*



Nuevo Registro de acceso para el deshollinado del conducto de humos.

*New cleaning hatch for chimney sweeping.*

# ZEUS

## La estufa con horno de mayor tamaño *The stove with the largest oven size*

- Estufa con horno de grandes dimensiones.
  - Horno y hogar de gran tamaño.
  - Diseño actual.
  - Rendimiento 85%.
  - Horno en inoxidable y ladrillo refractario.
- *Stove with large size oven.*
  - *Oven and stove with a large size.*
  - *Contemporary design.*
  - *Efficiency rate of 85%.*
  - *Oven in stainless steel and refractory bricks.*



### ZEUS

- Opcional sistema de ventilación de 360 m<sup>3</sup>/h. mediante dos ventiladores de dos velocidades y termostato de seguridad.
  - Cámara de combustión en Vermiculita.
- *Optional 360 m<sup>3</sup>/h. powered fan system, with two 2-speed fans and safety thermostat.*
  - *Interior lining in Vermiculite.*

A+





## Características Features



### **HORNO DE GRAN CAPACIDAD Y DESMONTABLE** **LARGE CAPACITY OVEN, DISMOUNTABLE**

Horno superior de gran tamaño en acero inoxidable con base de refractario y termómetro.

*Superior oven in stainless steel with a refractory base and thermometer.*



### **GRAN CÁMARA DE COMBUSTIÓN** **LARGE COMBUSTION CHAMBER**

Cámara de combustión grande y espaciosa. Revestida en vermiculita y acero. Incluye parrilla de asados.

*Large and spacious combustion chamber. Lined with stainless steel and vermiculite. Grill rack included.*



### **REGISTRO PARA LIMPIEZA** **CLEANING OPENING**

Incorpora un práctico registro para la limpieza de la cámara superior del horno.

*Includes a practical opening for cleaning the upper chamber of the oven.*



### **CONVERSIÓN EN MODELO RINCONERA** **CONVERTIBLE TO A CORNER VERSION**

Posibilidad de convertir el modelo en rinconero con una simple tapa (bajo pedido).

*Offers the possibility of converting into a corner version with a simple cover (upon request).*

ESTUFA CON HORNO / STOVE WITH OVEN

# HERMES

## Estética y discreta *Aesthetic and discreet*

- Disfrute de todas las ventajas en un tamaño más discreto.
  - Nuevo sistema de combustión que mejora el rendimiento hasta un 84% y reduce las emisiones de CO al 13% de O<sub>2</sub> hasta un 0,06%.
  - Cámara de combustión en Vermiculita.
- *Small size, yet great performance.*
  - *Efficiency 84%.*
  - *Minimum emissions of 0,06%.*
  - *Interior lining in Vermiculite.*



### HERMES

- Rendimiento 84%.
  - Opcional sistema de ventilación de 360 m<sup>3</sup>/h. mediante dos ventiladores de dos velocidades y termostato de seguridad.
- *Efficiency rate of 84%.*
  - *Optional 360 m<sup>3</sup>/h. powered fan system, with two 2-speed fans and safety thermostat.*

A+





Opcional versión rincón  
Optional corner version

**HERMES** (Versión de rincón / corner version)

- Rendimiento 84%.
- Opcional sistema de ventilación de 360 m<sup>3</sup>/h. mediante dos ventiladores de dos velocidades y termostato de seguridad.

- Efficiency rate of 84%.
- Optional 360 m<sup>3</sup>/h. powered fan system, with two 2-speed fans and safety thermostat.



HERMES

## Características Features



Horno superior en acero con termómetro. Incluye bandeja para el horno.

*Upper steel oven with thermometer. Includes tray for the oven.*



Cámara de combustión de acero y Vermiculite.

*Steel and Vermiculite combustion chamber.*



CARACTERÍSTICAS  
TÉCNICAS

TECHNICAL  
SPECIFICATIONS

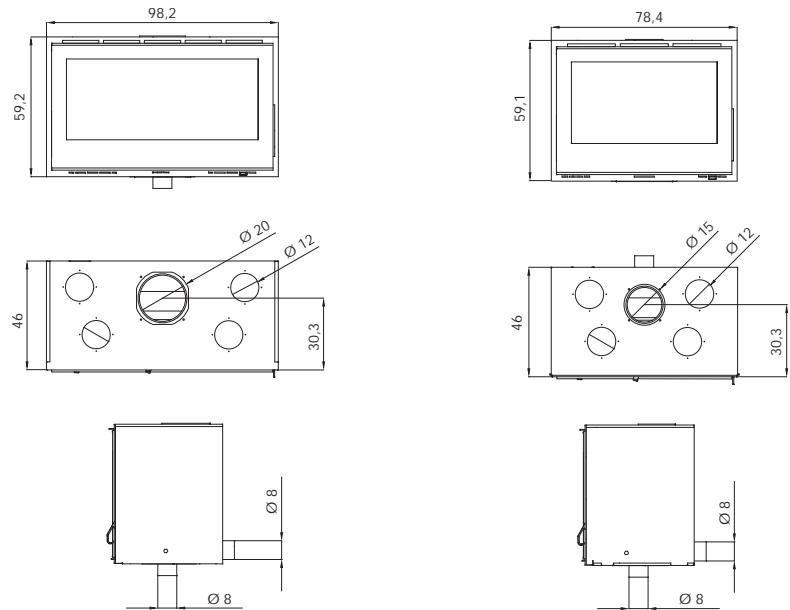

	I-100	I-80
Potencia <i>Output</i>	7 kW. - 16 kW.	7 kW. - 13 kW.
Potencia nominal: <i>Nominal Output</i>	10,78 kW.	9,48 kW.
Rendimiento <i>Efficiency</i>	87,3 %	85,09 %
Emisiones CO al 13% O <sub>2</sub> (mg/m <sup>3</sup> al 13% O <sub>2</sub> ) <i>Emission CO 13% O<sub>2</sub> (mg/m<sup>3</sup> at 13% O<sub>2</sub>)</i>	0,08 % (1118,45 mg/m <sup>3</sup> )	0,09 % - (1204,04 mg/m <sup>3</sup> )
Emisión de partículas al 13% O <sub>2</sub> <i>Particle emission at 13% O<sub>2</sub></i>	19,28 mg/m <sup>3</sup>	19,28 mg/m <sup>3</sup>
CnHm - OGC (mg/m <sup>3</sup> )	36,64 mg/m <sup>3</sup>	69,7 mg/m <sup>3</sup>
Nox mg/m <sup>3</sup>	74,39 mg/m <sup>3</sup>	74,39 mg/m <sup>3</sup>
Sistema de deflectores ajustables <i>Adjustable Baffle system</i>	✓	✓
Entradas de aire primario, secundario y terciario <i>Primary, secondary, and tertiary air supply</i>	✓	✓
Sistema cristal limpio: <i>Air- Wash system</i>	✓	✓
Entrada de aire exterior <i>External air Supply</i>	✓	✓
Modelo estanco <i>Airtight</i>	-	-
Cajón cenicero <i>Ash pan</i>	✓	✓
Revestimiento interior <i>Interior lining</i>	Vermiculita / Thermic / Eco	Vermiculita / Thermic / Eco
Peso <i>Weight</i>	129 / 133 / 150 Kg.	108 / 112 / 130 Kg.
Certificaciones <i>Certifications</i>	EN 16510 / EN 13229 / CE ECODESIGN / Stufe 2	EN 16510 / EN 13229 / CE ECODESIGN / Stufe 2
Clasificación energética <i>Energy label</i>	A+	A+

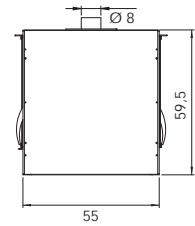
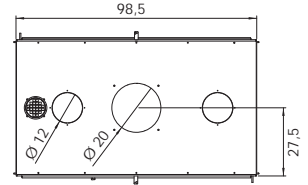
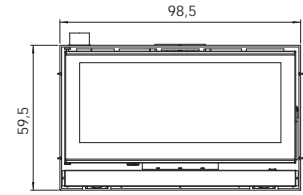
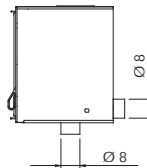
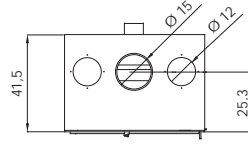
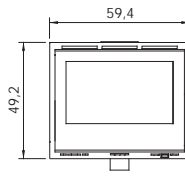
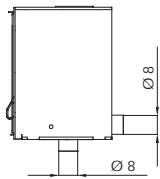
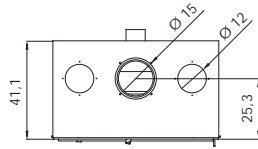
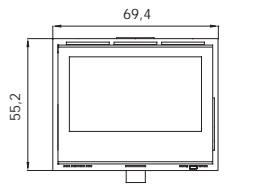

I-70	I-60	KRONOS 100 DOBLE CARA KRONOS 100 DOUBLE-SIDED
6 kW. - 12 kW.	4 kW. - 10 kW.	9 kW. - 17 kW.
8,18 kW.	6,2 kW.	15,3 kW.
85,09 %	81 %	79 %
0,09 % - (1204,04 mg/m <sup>3</sup> )	0,09 % - (1186,06 mg/m <sup>3</sup> )	0,1 % - (1199,62 mg/m <sup>3</sup> )
18,39 mg/m <sup>3</sup>	16,7 mg/m <sup>3</sup>	31,1 mg/m <sup>3</sup>
69,7 mg/m <sup>3</sup>	14,39 mg/m <sup>3</sup>	7,94 mg/m <sup>3</sup>
72,03 mg/m <sup>3</sup>	113,25 mg/m <sup>3</sup>	57,05 mg/m <sup>3</sup>
✓	✓	✓
✓	✓	✓
✓	✓	✓
✓	✓	✓
-	-	-
✓	-	✓
Vermiculita / Thermic / Eco	Vermiculita / Thermic	Vermiculita
88 / 91 / 100 Kg.	68 / 69 Kg.	153 Kg.
EN 16510 / EN 13229 / CE ECODESIGN / Stufe 2	EN 16510 / EN 13229 / CE ECODESIGN / Stufe 2	EN 16510 / EN 13229 / CE ECODESIGN / Stufe 2



CARACTERÍSTICAS  
TÉCNICAS

TECHNICAL  
SPECIFICATIONS

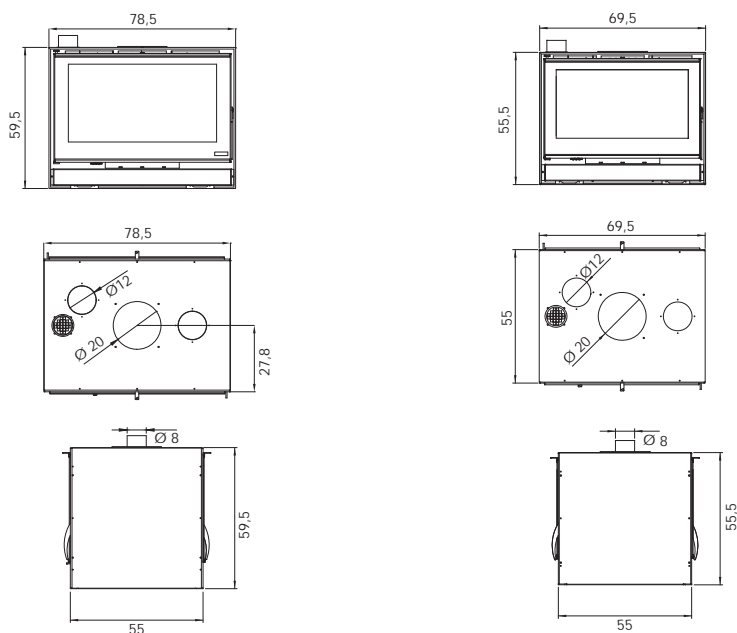

	<b>KRONOS 80 DOBLE CARA KRONOS 80 DOUBLE-SIDED</b>	<b>KRONOS 70 DOBLE CARA KRONOS 70 DOUBLE-SIDED</b>
Potencia <i>Output</i>	7 kW. - 16 kW.	6 kW. - 15 kW.
Potencia nominal: <i>Nominal Output</i>	14 kW.	12,7 kW.
Rendimiento <i>Efficiency</i>	79 %	82 %
Emisiones CO al 13% O <sub>2</sub> (mg/m <sup>3</sup> al 13% O <sub>2</sub> ) <i>Emission CO 13% O<sub>2</sub> (mg/m<sup>3</sup> at 13% O<sub>2</sub>)</i>	0,1 % - (1088,12 mg/m <sup>3</sup> )	0,08 % - (976,63 mg/m <sup>3</sup> )
Emisión de partículas al 13% O <sub>2</sub> <i>Particle emission at 13% O<sub>2</sub></i>	31,1 mg/m <sup>3</sup>	29,22 mg/m <sup>3</sup>
CnHm - OGC (mg/m <sup>3</sup> )	62,6 mg/m <sup>3</sup>	62,6 mg/m <sup>3</sup>
Nox mg/m <sup>3</sup>	84,50 mg/m <sup>3</sup>	84,50 mg/m <sup>3</sup>
Sistema de deflectores ajustables <i>Adjustable Baffle system</i>	✓	✓
Entradas de aire primario, secundario y terciario <i>Primary, secondary, and tertiary air supply</i>	✓	✓
Sistema cristal limpio: <i>Air- Wash system</i>	✓	✓
Entrada de aire exterior <i>External air Supply</i>	✓	✓
Modelo estanco <i>Airtight</i>	-	-
Cajón cenicero <i>Ash pan</i>	✓	✓
Revestimiento interior <i>Interior lining</i>	Vermiculita	Vermiculita
Peso <i>Weight</i>	129 Kg.	118 Kg.
Certificaciones <i>Certifications</i>	EN 16510 / EN 13229 / CE ECODESIGN / Stufe 2	EN 16510 / EN 13229 / CE ECODESIGN / Stufe 2
Clasificación energética <i>Energy label</i>	A	A+



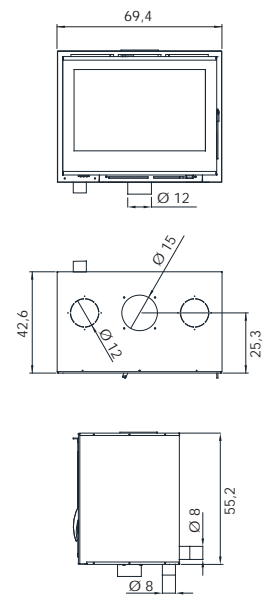
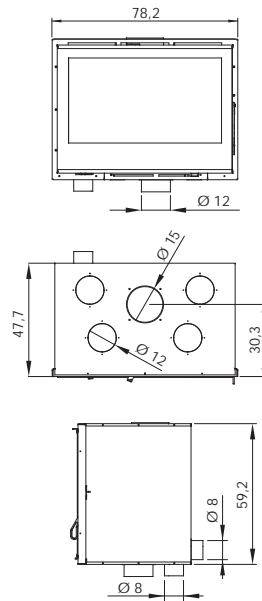
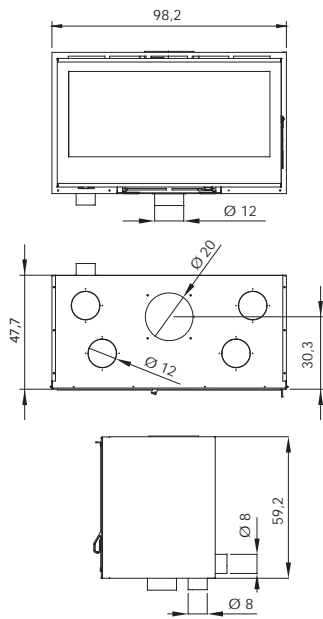

T-100-2	T-80-2	T-70-2
7 kW. - 16 kW.	7 kW. - 13 kW.	6 kW. - 12 kW.
10,78 kW.	9,48 kW.	8,18 kW.
87,3 %	85,09 %	85,09 %
0,08 % - (1118,45 mg/m <sup>3</sup> )	0,09 % - (1204,04 mg/m <sup>3</sup> )	0,09 % - (1204,04 mg/m <sup>3</sup> )
19,28 mg/m <sup>3</sup>	19,28 mg/m <sup>3</sup>	18,39 mg/m <sup>3</sup>
36,64 mg/m <sup>3</sup>	69,7 mg/m <sup>3</sup>	69,7 mg/m <sup>3</sup>
74,39 mg/m <sup>3</sup>	74,39 mg/m <sup>3</sup>	72,03 mg/m <sup>3</sup>
✓	✓	✓
✓	✓	✓
✓	✓	✓
✓	✓	✓
-	-	-
-	-	-
Vermiculita	Vermiculita	Vermiculita
127 Kg.	109 Kg.	85 Kg.
EN 16510 / EN 13229 / CE ECODESIGN / Stufe 2	EN 16510 / EN 13229 / CE ECODESIGN / Stufe 2	EN 16510 / EN 13229 / CE ECODESIGN / Stufe 2



CARACTERÍSTICAS  
TÉCNICAS

TECHNICAL  
SPECIFICATIONS

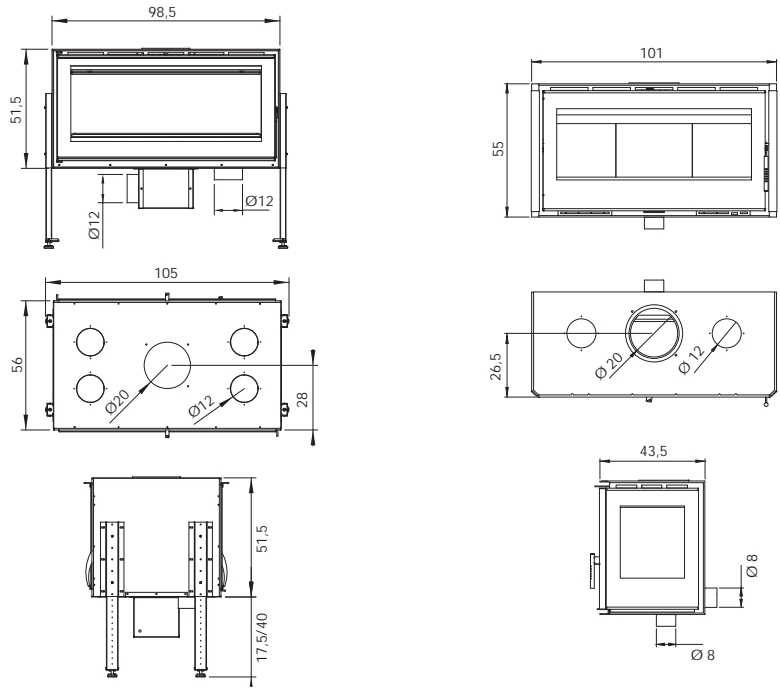

Potencia  
Output

Potencia nominal:  
Nominal Output

Rendimiento  
Efficiency

Emisiones CO al 13% O<sub>2</sub> (mg/m<sup>3</sup> al 13% O<sub>2</sub>)  
Emission CO 13% O<sub>2</sub> (mg/m<sup>3</sup> at 13% O<sub>2</sub>)

Emisión de partículas al 13% O<sub>2</sub>  
Particle emission at 13% O<sub>2</sub>

CnHm - OGC (mg/m<sup>3</sup>)

Nox mg/m<sup>3</sup>

Sistema de deflectores ajustables  
Adjustable Baffle system

Entradas de aire primario, secundario y terciario  
Primary, secondary, and tertiary air supply

Sistema cristal limpio:  
Air- Wash system

Entrada de aire exterior  
External air Supply

Modelo estanco  
Airtight

Cajón cenicero  
Ash pan

Revestimiento interior  
Interior lining

Peso  
Weight

Certificaciones  
Certifications

Clasificación energética  
Energy label

**HK-100 DOBLE CARA**  
**HK-100 DOUBLE-SIDED**

9 kW. - 17 kW.

15,3 kW.

79 %

0,1 % - (1199,62 mg/m<sup>3</sup>)

31,1 mg/m<sup>3</sup>

7,94 mg/m<sup>3</sup>

57,05 mg/m<sup>3</sup>



-

-

Vermiculita

146 Kg.

EN 16510 / EN 13229 / CE  
ECODESIGN / Stufe 2



**A-100-2**

7 kW. - 15 kW.

10,9 kW.

78 %

0,07 % - (912 mg/m<sup>3</sup>)

9 mg/m<sup>3</sup>

45 mg/m<sup>3</sup>

98 mg/m<sup>3</sup>



-



Thermic

122 Kg.

EN 16510 / EN 13229 / CE  
ECODESIGN / Stufe 2



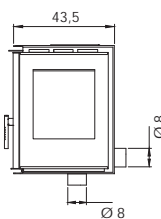
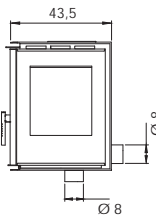
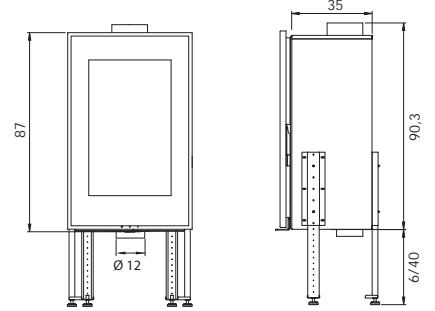
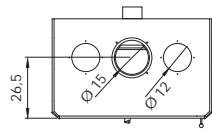
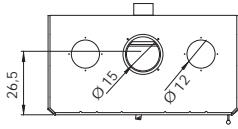
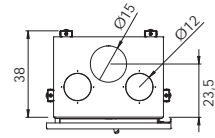
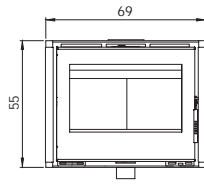
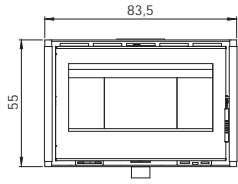

**A-85-2**

**A-70-2**

**VISION INSERTABLE  
VISION INSERT**

6 kW. - 13 kW.

5 kW. - 12 kW.

4 kW. - 10 kW.

9,4 kW.

7,8 kW.

7 kW.

75 %

75 %

80,40 %

0,11 % - (1342 mg/m<sup>3</sup>)

0,11 % - (1342 mg/m<sup>3</sup>)

0,085% - (24,2 mg/m<sup>3</sup>)

15 mg/m<sup>3</sup>

15 mg/m<sup>3</sup>

24,2 mg/m<sup>3</sup>

84 mg/m<sup>3</sup>

84 mg/m<sup>3</sup>

104,1 mg/m<sup>3</sup>

98 mg/m<sup>3</sup>

94 mg/m<sup>3</sup>

98,50 mg/m<sup>3</sup>



-

-



-

Thermic

Thermic

Vermiculita

103 Kg.

90 Kg.

120 Kg.

EN 16510 / EN 13229 / CE  
ECODESIGN

EN 16510 / EN 13229 / CE  
ECODESIGN

EN 16510 / EN 13229 / CE  
ECODESIGN / Stufe 2





CARACTERÍSTICAS  
TÉCNICAS

TECHNICAL  
SPECIFICATIONS

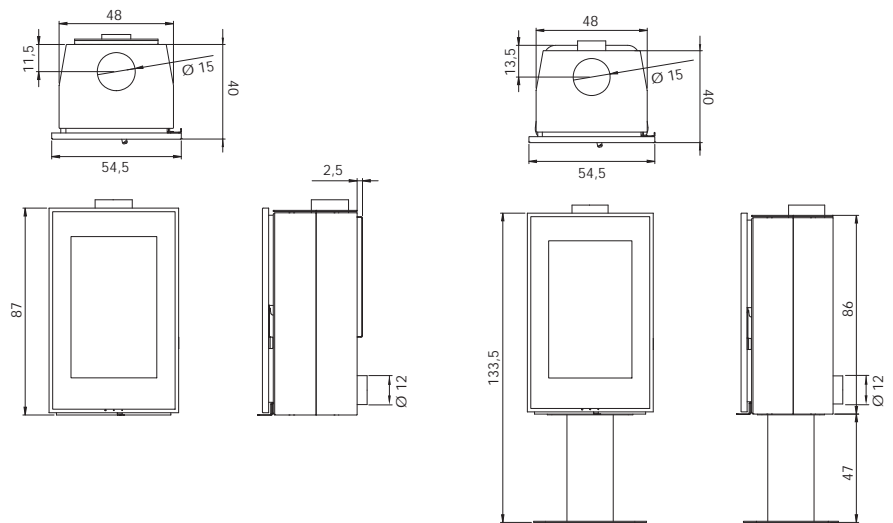

	<b>VISION SUSPENDIDA</b> <i>VISION SUSPENDED</i>	<b>VISION SOBRE PIE</b> <i>VISION FREE-STANDING</i>
Potencia <i>Output</i>	4 kW. - 10 kW.	4 kW. - 10 kW.
Potencia nominal: <i>Nominal Output</i>	7 kW.	7 kW.
Rendimiento <i>Efficiency</i>	80,40 %	80,40 %
Emisiones CO al 13% O <sub>2</sub> (mg/m <sup>3</sup> al 13% O <sub>2</sub> ) <i>Emission CO 13% O<sub>2</sub> (mg/m<sup>3</sup> at 13% O<sub>2</sub>)</i>	0,085 % - (24,2 mg/m <sup>3</sup> )	0,085 % - (24,2 mg/m <sup>3</sup> )
Emisión de partículas al 13% O <sub>2</sub> <i>Particle emission at 13% O<sub>2</sub></i>	24,2 mg/m <sup>3</sup>	24,2 mg/m <sup>3</sup>
CnHm - OGC (mg/m <sup>3</sup> )	104,1 mg/m <sup>3</sup>	104,1 mg/m <sup>3</sup>
Nox mg/m <sup>3</sup>	98,50 mg/m <sup>3</sup>	98,50 mg/m <sup>3</sup>
Sistema de deflectores ajustables <i>Adjustable Baffle system</i>	✓	✓
Entradas de aire primario, secundario y terciario <i>Primary, secondary, and tertiary air supply</i>	✓	✓
Sistema cristal limpio: <i>Air- Wash system</i>	✓	✓
Entrada de aire exterior <i>External air Supply</i>	✓	✓
Modelo estanco <i>Airtight</i>	✓	✓
Cajón cenicero <i>Ash pan</i>	-	-
Revestimiento interior <i>Interior lining</i>	Vermiculita	Vermiculita
Peso <i>Weight</i>	150 Kg.	175 Kg.
Certificaciones <i>Certifications</i>	EN 16510 / EN 13240 / CE ECODESIGN / Stufe 2	EN 16510 / EN 13240 / CE ECODESIGN / Stufe 2
Clasificación energética <i>Energy label</i>	<b>A+</b>	<b>A+</b>

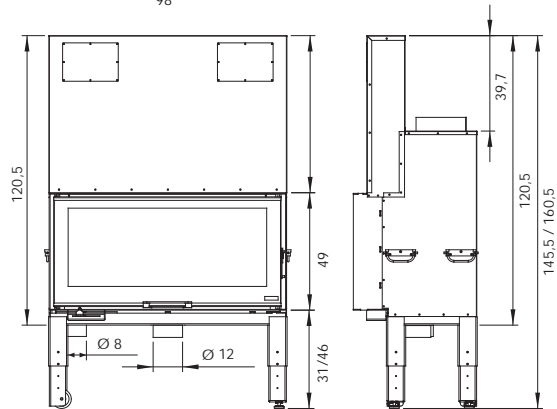
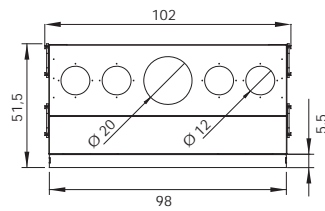
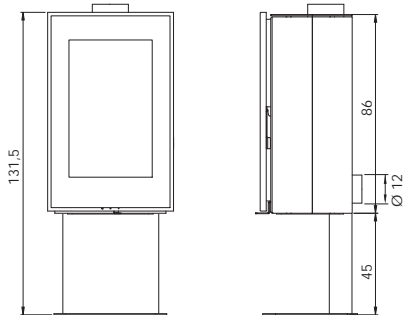
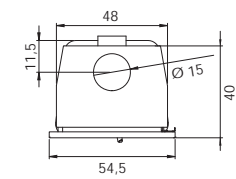

### VISION STAND

### G-100

4 kW. - 10 kW.

9 kW. - 17 kW.

7 kW.

15,4 kW.

80,40 %

76 %

0,085 % - (24,2 mg/m<sup>3</sup>)

0,08 % - (972,18 mg/m<sup>3</sup>)

24,2 mg/m<sup>3</sup>

12,7 mg/m<sup>3</sup>

104,1 mg/m<sup>3</sup>

15,92 mg/m<sup>3</sup>

98,50 mg/m<sup>3</sup>

124,59 mg/m<sup>3</sup>



-

-

Vermiculita

Thermic

181 Kg.

245 Kg.

EN 16510 / EN 13240 / CE  
ECODESIGN / Stufe 2

EN 16510 / EN 13229 / CE  
ECODESIGN / Stufe 2



CARACTERÍSTICAS  
TÉCNICAS

TECHNICAL  
SPECIFICATIONS

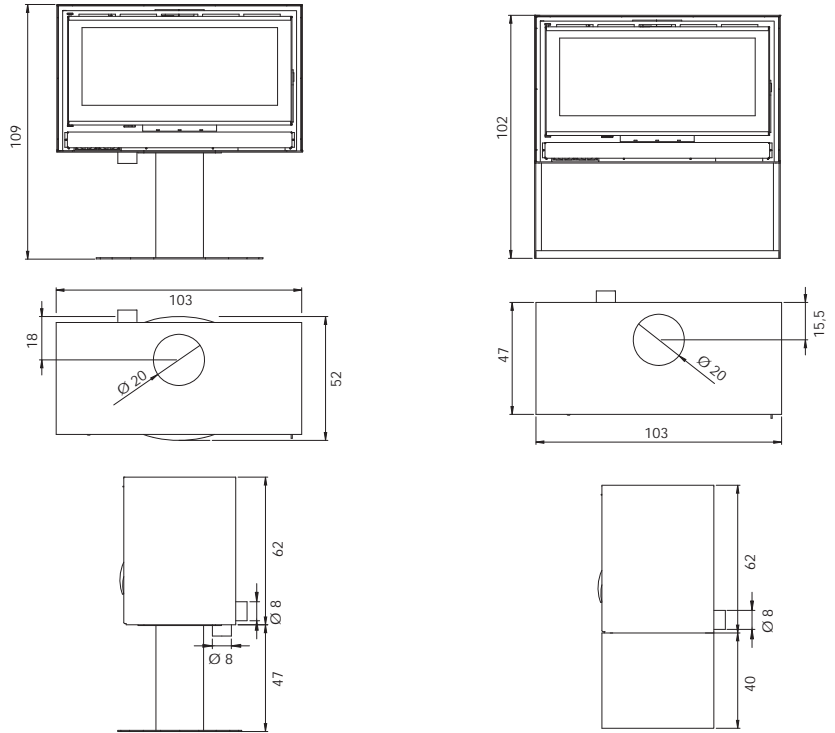

	<b>RK-100 PIE</b> <b>RK-100 FREE-STANDING</b>	<b>RK-100 LEÑERA</b> <b>RK-100 WITH LOG STORE</b>
Potencia <i>Output</i>	6 kW. - 15 kW.	6 kW. - 15 kW.
Potencia nominal: <i>Nominal Output</i>	9,3 kW.	9,3 kW.
Rendimiento <i>Efficiency</i>	78 %	78 %
Emisiones CO al 13% O <sub>2</sub> (mg/m <sup>3</sup> al 13% O <sub>2</sub> ) <i>Emission CO 13% O<sub>2</sub> (mg/m<sup>3</sup> at 13% O<sub>2</sub>)</i>	0,09 % - (744,8 mg/m <sup>3</sup> )	0,09 % - (744,8 mg/m <sup>3</sup> )
Emisión de partículas al 13% O <sub>2</sub> <i>Particle emission at 13% O<sub>2</sub></i>	14,1 mg/m <sup>3</sup>	14,1 mg/m <sup>3</sup>
CnHm - OGC (mg/m <sup>3</sup> )	36,7 mg/m <sup>3</sup>	36,7 mg/m <sup>3</sup>
Nox mg/m <sup>3</sup>	77,50 mg/m <sup>3</sup>	77,50 mg/m <sup>3</sup>
Sistema de deflectores ajustables <i>Adjustable Baffle system</i>	✓	✓
Entradas de aire primario, secundario y terciario <i>Primary, secondary, and tertiary air supply</i>	✓	✓
Sistema cristal limpio: <i>Air- Wash system</i>	✓	✓
Entrada de aire exterior <i>External air Supply</i>	✓	✓
Modelo estanco <i>Airtight</i>	-	-
Cajón cenicero <i>Ash pan</i>	✓	✓
Revestimiento interior <i>Interior lining</i>	Vermiculita / Thermic	Vermiculita / Thermic
Peso <i>Weight</i>	210 / 222 Kg.	227 / 239 Kg.
Certificaciones <i>Certifications</i>	EN 16510 / EN 13240 / CE ECODESIGN / Stufe 2	EN 16510 - EN 13240 / CE ECODESIGN / Stufe 2
Clasificación energética <i>Energy label</i>	<b>A</b>	<b>A</b>

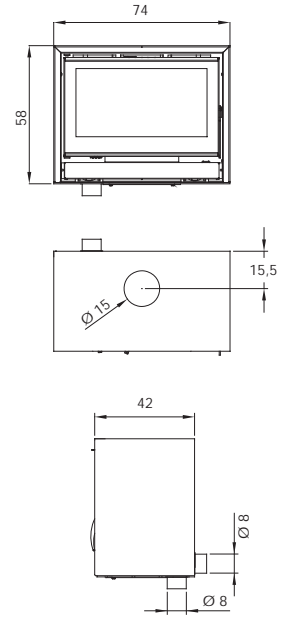
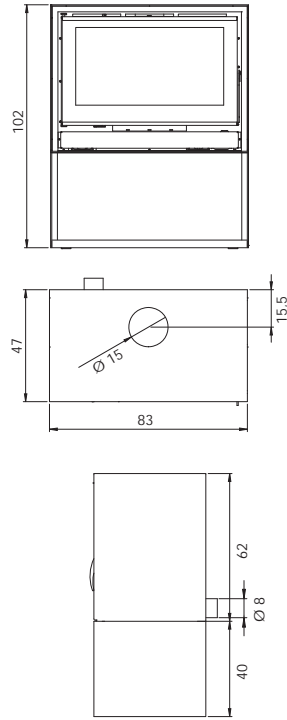
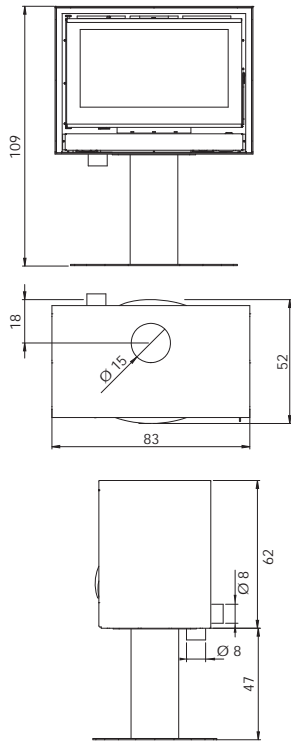

**RK-80 PIE**  
**RK-80 FREE-STANDING**

**RK-80 LEÑERA**  
**RK-80 WITH LOG STORE**

**RK-70**

6 kW. - 13 kW.

6 kW. - 13 kW.

5 kW. - 12 kW.

8 kW.

8 kW.

6,75 kW.

78,5 %

78,5 %

79 %

0,09 % - (792,3 mg/m<sup>3</sup>)

0,09 % - (792,3 mg/m<sup>3</sup>)

0,09 % - (839 mg/m<sup>3</sup>)

14,7 mg/m<sup>3</sup>

14,7 mg/m<sup>3</sup>

15,2 mg/m<sup>3</sup>

67 mg/m<sup>3</sup>

67 mg/m<sup>3</sup>

96,8 mg/m<sup>3</sup>

92,70 mg/m<sup>3</sup>

92,70 mg/m<sup>3</sup>

107,60 mg/m<sup>3</sup>



-

-

-



Vermiculita / Thermic

Vermiculita / Thermic

Vermiculita / Thermic

140 / 170 Kg.

140 / 170 Kg.

85 / 115 Kg.

EN 16510 / EN 13240 / CE  
ECODESIGN / Stufe 2

EN 16510 / EN 13240 / CE  
ECODESIGN / Stufe 2

EN 16510 / EN 13240 / CE  
ECODESIGN / Stufe 2





CARACTERÍSTICAS  
TÉCNICAS

TECHNICAL  
SPECIFICATIONS

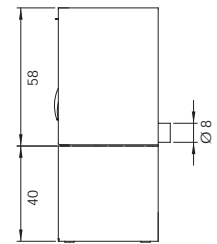
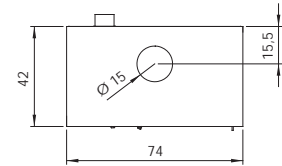
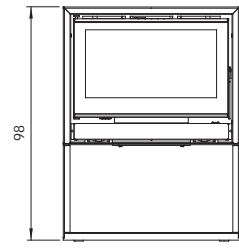
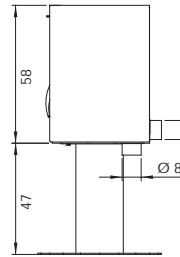
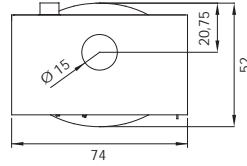
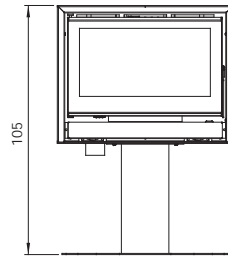

**RK-70 PIE**  
**RK-70 FREE-STANDING**

**RK-70 LEÑERA**  
**RK-70 WITH LOG STORE**

Potencia <i>Output</i>	5 kW. - 12 kW.	5 kW. - 12 kW.
Potencia nominal: <i>Nominal Output</i>	6,75 kW.	6,75 kW.
Rendimiento <i>Efficiency</i>	79 %	79 %
Emissiones CO al 13% O <sub>2</sub> (mg/m <sup>3</sup> al 13% O <sub>2</sub> ) <i>Emission CO 13% O<sub>2</sub> (mg/m<sup>3</sup> at 13% O<sub>2</sub>)</i>	0,09 % - (839 mg/m <sup>3</sup> )	0,09 % - (839 mg/m <sup>3</sup> )
Emisión de partículas al 13% O <sub>2</sub> <i>Particle emission at 13% O<sub>2</sub></i>	15,2 mg/m <sup>3</sup>	15,2 mg/m <sup>3</sup>
CnHm - OGC (mg/m <sup>3</sup> )	96,8 mg/m <sup>3</sup>	96,8 mg/m <sup>3</sup>
Nox mg/m <sup>3</sup>	107,60 mg/m <sup>3</sup>	107,60 mg/m <sup>3</sup>
Sistema de deflectores ajustables <i>Adjustable Baffle system</i>	✓	✓
Entradas de aire primario, secundario y terciario <i>Primary, secondary, and tertiary air supply</i>	✓	✓
Sistema cristal limpio: <i>Air- Wash system</i>	✓	✓
Entrada de aire exterior <i>External air Supply</i>	✓	✓
Modelo estanco <i>Airtight</i>	-	-
Cajón cenicero <i>Ash pan</i>	✓	✓
Revestimiento interior <i>Interior lining</i>	Vermiculita / Thermico	Vermiculita / Thermic
Peso <i>Weight</i>	150 / 161 Kg.	158 / 169 Kg.
Certificaciones <i>Certifications</i>	EN 16510 / EN 13240 / CE ECODESIGN / Stufe 2	EN 16510 / EN 13240 / CE ECODESIGN / Stufe 2
Clasificación energética <i>Energy label</i>	A	A

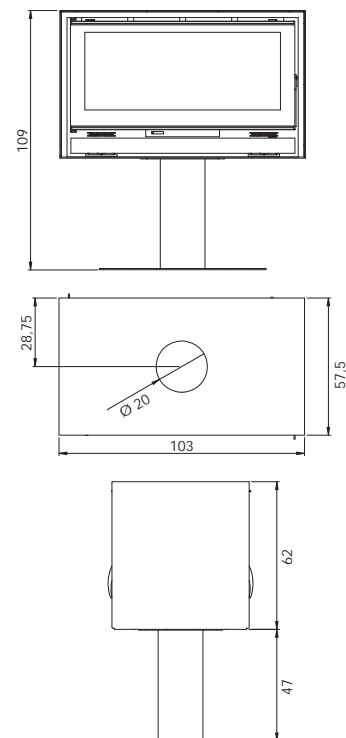
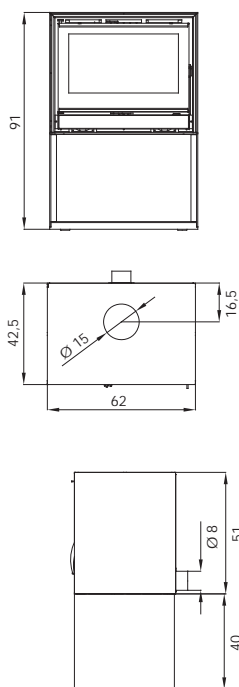
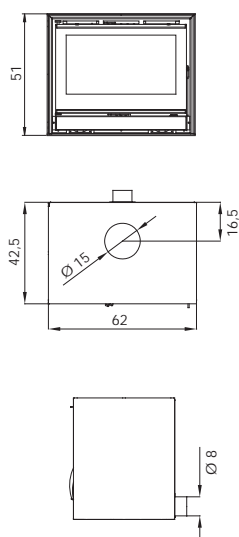

<b>RK-60</b>	<b>RK-60 LEÑERA RK-60 WITH LOG STORE</b>	<b>RK-100 DOBLE CARA RK-100 DOUBLE-SIDED</b>
4 kW. - 10 kW.	4 kW. - 10 kW.	8 kW. - 17 kW.
6,2 kW.	6,2 kW.	15,3 kW.
81 %	81 %	79 %
0,09 % - (1186,06 mg/m <sup>3</sup> )	0,09 % - (1186,06 mg/m <sup>3</sup> )	0,1 % - (1199,62 mg/m <sup>3</sup> )
16,7 mg/m <sup>3</sup>	16,7 mg/m <sup>3</sup>	31,1 mg/m <sup>3</sup>
14,39 mg/m <sup>3</sup>	14,39 mg/m <sup>3</sup>	7,94 mg/m <sup>3</sup>
113,25 mg/m <sup>3</sup>	113,25 mg/m <sup>3</sup>	57,05 mg/m <sup>3</sup>
✓	✓	✓
✓	✓	✓
✓	✓	✓
✓	✓	-
-	-	-
-	-	✓
Vermiculita / Thermic	Vermiculita / Thermic	Vermiculita
93 / 105 Kg.	123 / 130 Kg.	260 Kg.
EN 16510 / EN 13240 / CE ECODESIGN / Stufe 2	EN 16510 / EN 13240 / CE ECODESIGN / Stufe 2	EN 16510 / EN 13240 / CE ECODESIGN / Stufe 2



CARACTERÍSTICAS  
TÉCNICAS

TECHNICAL  
SPECIFICATIONS

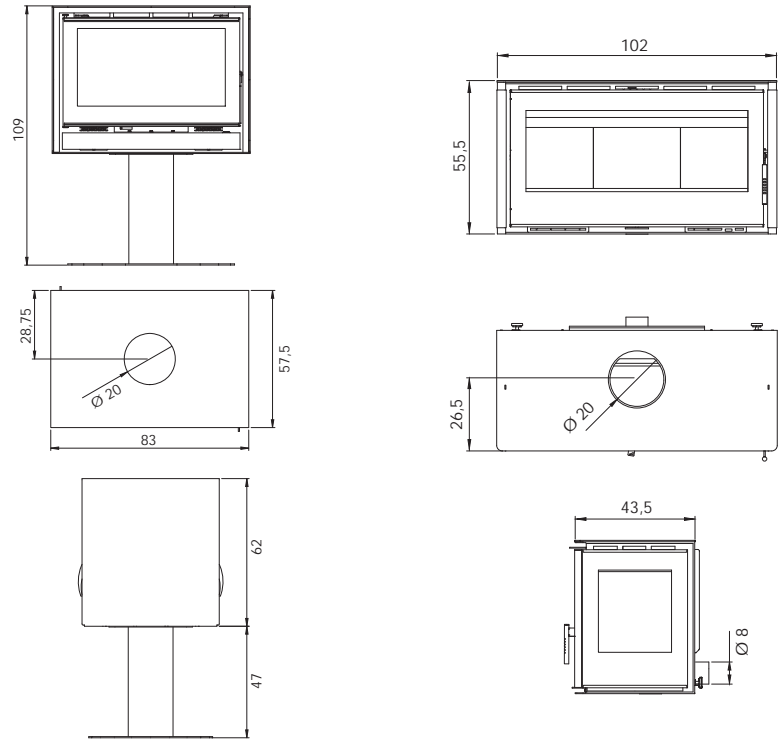

	<b>RK-80 DOBLE CARA RK-80 DOUBLE-SIDED</b>	<b>RA-100-2</b>
Potencia <i>Output</i>	7 kW. - 16 kW.	7 kW. - 15 kW.
Potencia nominal: <i>Nominal Output</i>	14 kW.	10,9 kW.
Rendimiento <i>Efficiency</i>	79 %	78 %
Emissiones CO al 13% O <sub>2</sub> (mg/m <sup>3</sup> al 13% O <sub>2</sub> ) <i>Emission CO 13% O<sub>2</sub> (mg/m<sup>3</sup> at 13% O<sub>2</sub>)</i>	0,1 % - (1088,12 mg/m <sup>3</sup> )	0,07 % - (912 mg/m <sup>3</sup> )
Emisión de partículas al 13% O <sub>2</sub> <i>Particle emission at 13% O<sub>2</sub></i>	31,1 mg/m <sup>3</sup>	9 mg/m <sup>3</sup>
CnHm - OGC (mg/m <sup>3</sup> )	62,6 mg/m <sup>3</sup>	45 mg/m <sup>3</sup>
Nox mg/m <sup>3</sup>	84,50 mg/m <sup>3</sup>	98 mg/m <sup>3</sup>
Sistema de deflectores ajustables <i>Adjustable Baffle system</i>	✓	✓
Entradas de aire primario, secundario y terciario <i>Primary, secondary, and tertiary air supply</i>	✓	✓
Sistema cristal limpio: <i>Air- Wash system</i>	✓	✓
Entrada de aire exterior <i>External air Supply</i>	-	✓
Modelo estanco <i>Airtight</i>	-	-
Cajón cenicero <i>Ash pan</i>	✓	✓
Revestimiento interior <i>Interior lining</i>	Vermiculita	Thermic
Peso <i>Weight</i>	225 Kg.	149 Kg.
Certificaciones <i>Certifications</i>	EN 16510 / EN 13240 / CE ECODESIGN / Stufe 2	EN 16510 / EN 13240 / CE ECODESIGN / Stufe 2
Clasificación energética <i>Energy label</i>	<b>A</b>	<b>A+</b>

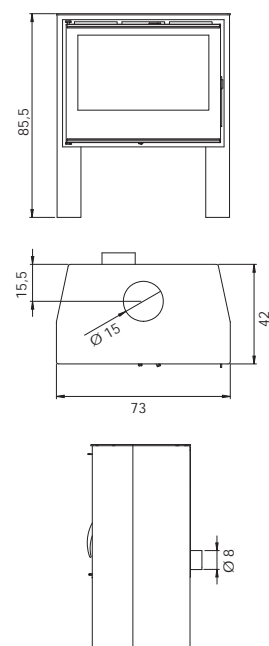
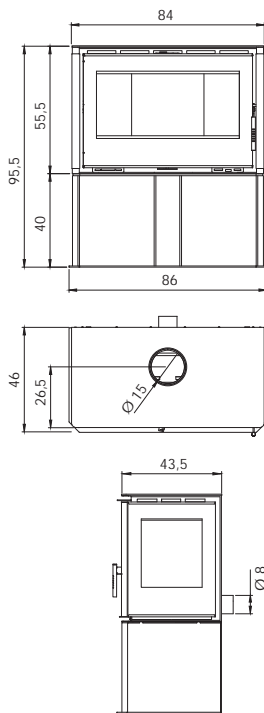
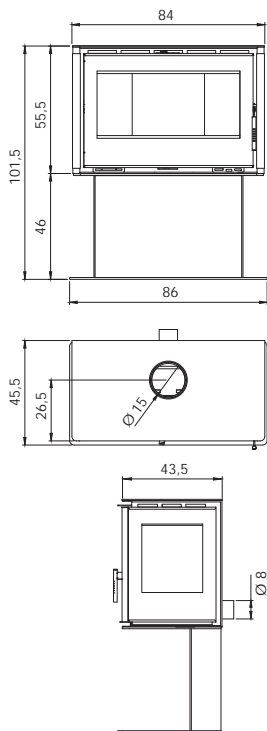

**RA-85-2 PIE**  
**RA-85-2 FREE-STANDING**

**RA-85-2 LEÑERA**  
**RA-85-2 WITH LOG STORE**

**ARES-2**

6 kW. - 13 kW.

6 kW. - 13 kW.

6 kW. - 12 kW.

9,4 kW.

9,4 kW.

8,18 kW.

75 %

75 %

85,09 %

0,11 % - (1342 mg/m<sup>3</sup>)

0,11 % - (1342 mg/m<sup>3</sup>)

0,09 % - (1204,04 mg/m<sup>3</sup>)

15 mg/m<sup>3</sup>

15 mg/m<sup>3</sup>

18,39 mg/m<sup>3</sup>

84 mg/m<sup>3</sup>

84 mg/m<sup>3</sup>

69,7 mg/m<sup>3</sup>

98 mg/m<sup>3</sup>

98 mg/m<sup>3</sup>

72,03 mg/m<sup>3</sup>



-

-

-



Thermic

Thermic

Thermic

190 Kg.

174 Kg.

135 Kg.

EN 16510 / EN 13240 / CE  
ECODESIGN

EN 16510 / EN 13240 / CE  
ECODESIGN

EN 16510 / EN 13240 / CE  
ECODESIGN / Stufe 2





CARACTERÍSTICAS  
TÉCNICAS

TECHNICAL  
SPECIFICATIONS

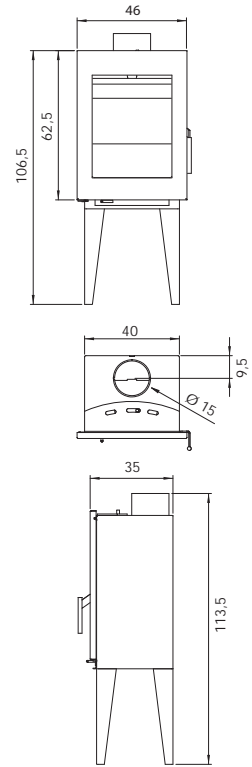
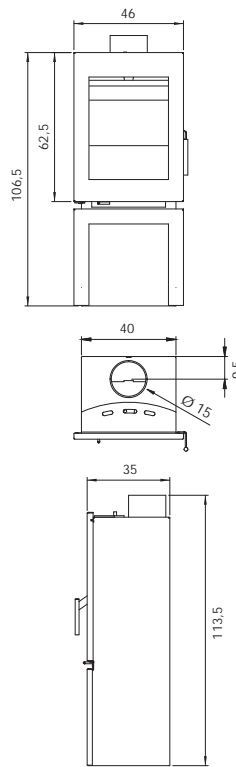

Potencia  
*Output*

4 kW. - 11 kW.

4 kW. - 11 kW.

Potencia nominal:  
*Nominal Output*

7,18 kW.

7,18 kW.

Rendimiento  
*Efficiency*

80,95 %

80,95 %

Emisiones CO al 13% O<sub>2</sub> (mg/m<sup>3</sup> al 13% O<sub>2</sub>)  
*Emission CO 13% O<sub>2</sub> (mg/m<sup>3</sup> at 13% O<sub>2</sub>)*

0,09% - (1081 mg/m<sup>3</sup>)

0,09% - (1081 mg/m<sup>3</sup>)

Emisión de partículas al 13% O<sub>2</sub>  
*Particle emission at 13% O<sub>2</sub>*

17,1 mg/m<sup>3</sup>

17,1 mg/m<sup>3</sup>

CnHm - OGC (mg/m<sup>3</sup>)

73,75 mg/m<sup>3</sup>

73,75 mg/m<sup>3</sup>

Nox mg/m<sup>3</sup>

101,84 mg/m<sup>3</sup>

101,84 mg/m<sup>3</sup>

Sistema de deflectores ajustables  
*Adjustable Baffle system*



Entradas de aire primario, secundario y terciario  
*Primary, secondary, and tertiary air supply*



Sistema cristal limpio:  
*Air- Wash system*



Entrada de aire exterior  
*External air Supply*

-

-

Modelo estanco  
*Airtight*

-

-

Cajón cenicero  
*Ash pan*



Revestimiento interior  
*Interior lining*

Vermiculita

Vermiculita

Peso  
*Weight*

76 Kg.

76 Kg.

Certificaciones  
*Certifications*

EN 16510 / EN 13240 / CE  
ECODESIGN / Stufe 2

EN 16510 / EN 13240 / CE  
ECODESIGN / Stufe 2

Clasificación energética  
*Energy label*



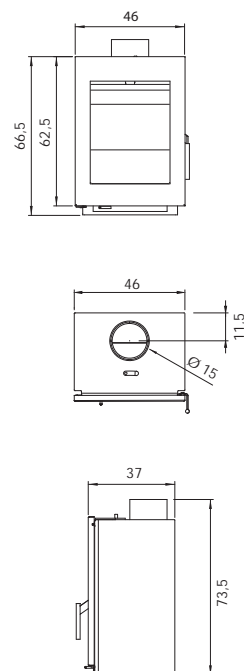
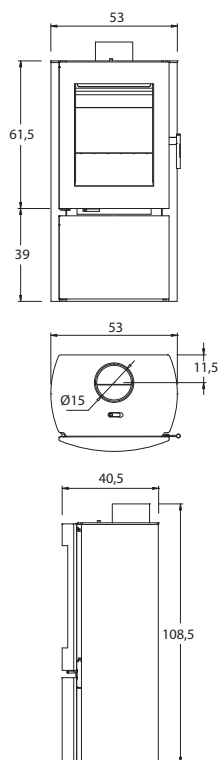
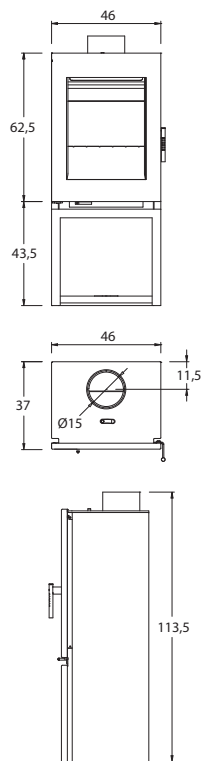

### MAIA LARGE

### MAIA ROUND

### MAIA WALL

4 kW. - 11 kW.

4 kW. - 11 kW.

4 kW. - 11 kW.

7,18 kW.

7,18 kW.

7,18 kW.

80,95 %

80,95 %

80,95 %

0,09% - (1081 mg/m<sup>3</sup>)

0,09% - (1081 mg/m<sup>3</sup>)

0,09% - (1081 mg/m<sup>3</sup>)

17,1 mg/m<sup>3</sup>

17,1 mg/m<sup>3</sup>

17,1 mg/m<sup>3</sup>

73,75 mg/m<sup>3</sup>

73,75 mg/m<sup>3</sup>

73,75 mg/m<sup>3</sup>

101,84 mg/m<sup>3</sup>

101,84 mg/m<sup>3</sup>

101,84 mg/m<sup>3</sup>



-

-

-

-

-

-



Vermiculita

Vermiculita

Vermiculita

84 Kg.

90 Kg.

76 Kg.

EN 16510 / EN 13240 / CE  
ECODESIGN / Stufe 2

EN 16510 / EN 13240 / CE  
ECODESIGN / Stufe 2

EN 16510 / EN 13240 / CE  
ECODESIGN / Stufe 2



CARACTERÍSTICAS  
TÉCNICAS

TECHNICAL  
SPECIFICATIONS

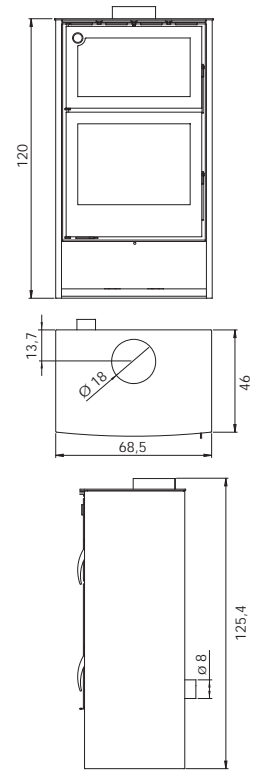
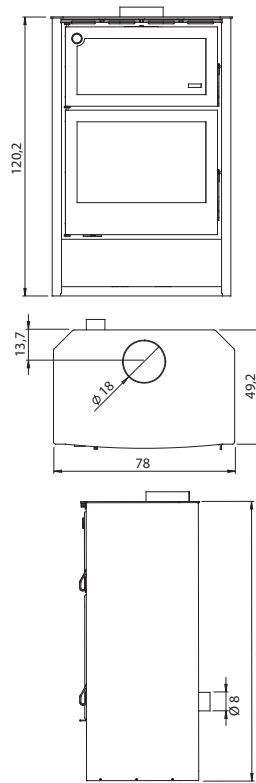

	ZEUS	ATLAS
Potencia <i>Output</i>	7 kW. - 13 kW.	6 kW. - 12 kW.
Potencia nominal: <i>Nominal Output</i>	8,7 kW.	10 kW.
Rendimiento <i>Efficiency</i>	84,90 %	84 %
Emisiones CO al 13% O <sub>2</sub> (mg/m <sup>3</sup> al 13% O <sub>2</sub> ) <i>Emission CO 13% O<sub>2</sub> (mg/m<sup>3</sup> at 13% O<sub>2</sub>)</i>	0,18 % - (2347 mg/m <sup>3</sup> )	0,03% - (375 mg/m <sup>3</sup> )
Emisión de partículas al 13% O <sub>2</sub> <i>Particle emission at 13% O<sub>2</sub></i>	35,9 mg/m <sup>3</sup>	30,8 mg/m <sup>3</sup>
CnHm - OGC (mg/m <sup>3</sup> )	169,27 mg/m <sup>3</sup>	57,5 mg/m <sup>3</sup>
Nox mg/m <sup>3</sup>	71,89 mg/m <sup>3</sup>	31 mg/m <sup>3</sup>
Sistema de deflectores ajustables <i>Adjustable Baffle system</i>	✓	✓
Entradas de aire primario, secundario y terciario <i>Primary, secondary, and tertiary air supply</i>	✓	✓
Sistema cristal limpio: <i>Air- Wash system</i>	✓	✓
Entrada de aire exterior <i>External air Supply</i>	✓	✓
Modelo estanco <i>Airtight</i>	-	-
Cajón cenicero <i>Ash pan</i>	✓	✓
Revestimiento interior <i>Interior lining</i>	Vermiculita	Thermic
Peso <i>Weight</i>	214 Kg.	170 Kg.
Certificaciones <i>Certifications</i>	EN 16510 / EN 13240 / CE ECODESIGN	EN 16510 / EN 13240 / CE ECODESIGN / Stufe 2
Clasificación energética <i>Energy label</i>	A+	A+

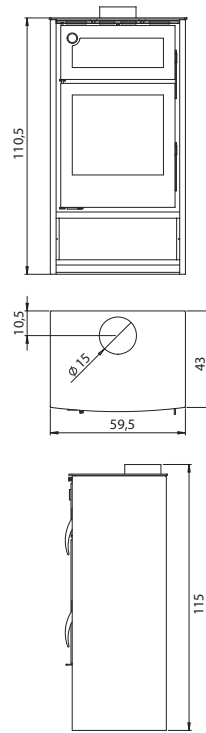
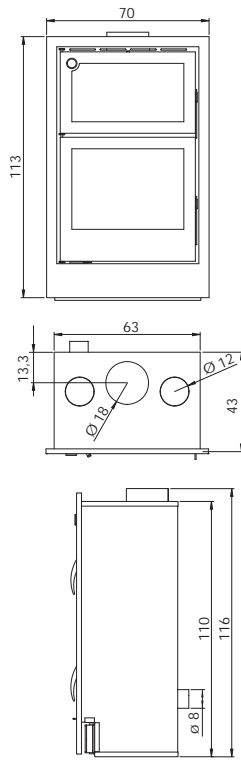

**ATLAS INSERTABLE  
ATLAS INSERT**

**HERMES**

6 kW. - 12 kW.

5 kW. - 10 kW.

10 kW.

8,7 kW.

84 %

84 %

0,03% - (375 mg/m<sup>3</sup>)

0,06% - (750 mg/m<sup>3</sup>)

30,8 mg/m<sup>3</sup>

54,4 mg/m<sup>3</sup>

57,5 mg/m<sup>3</sup>

37 mg/m<sup>3</sup>

31 mg/m<sup>3</sup>

52 mg/m<sup>3</sup>



-

-

-



Thermic

Vermiculita

130 Kg.

125 Kg.

EN 16510 / EN 13229 / CE  
ECODESIGN / Stufe 2

EN 16510 / EN 13240 / CE  
ECODESIGN





**DIFUSOR 4 TOMAS  
CONVECTION OUTLET**

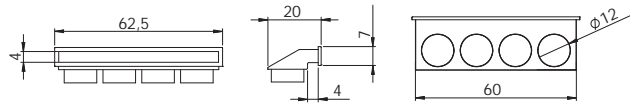

**DIFUSOR 2 TOMAS  
CONVECTION OUTLET**

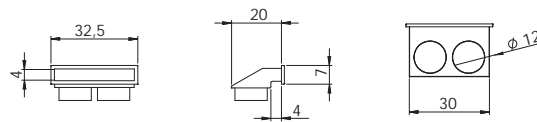

**BOX 180**

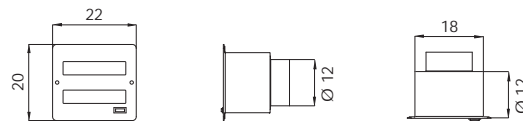

**BOX ECO SILENT**

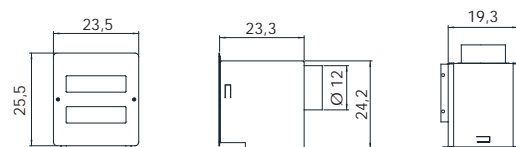





**Cocinas CARBEL, S.L.**  
Tel.: (+34) 96 134 07 16  
[www.carbel.net](http://www.carbel.net)  
[carbel@carbel.net](mailto:carbel@carbel.net)

¡Síguenos!  
Follow us!



El fabricante se reserva el derecho de introducir las modificaciones que estime necesarias en beneficio del producto y del cliente.  
*CARBEL reserves the right to alter designs and specification without notice.*

Distribuidor / Dealer: