



ORTAL

# CONTENTS

---

<b>NEW!</b>	THE WILDERNESS COLLECTION.....	04-05
	ABOUT.....	06-09
	FRONT FACING.....	10-15
	CORNER.....	16-21
	THREE SIDES.....	22-27
	SPACE CREATOR.....	28-33
	TUNNEL.....	34-39
	INDOOR / OUTDOOR.....	40-43
	STAND ALONE.....	44-53
	ISLAND & CIRCLE.....	54-59
	COMMERCIAL.....	60-61
	ADVANTAGES - DESIGN & TECHNOLOGY.....	62-81
<b>150+</b>	OVER 150 MODELS.....	82-85

## **NEW!** THE WILDERNESS COLLECTION

Deeply inspired by nature, this versatile new line of burning logs is designed with a natural look and feel that will make you rediscover fire.

Ortal has taken the best of the great outdoors, and channeled it to create a new standard of fireside experience. The Wilderness Collection combines ceramic log technology with an idyllic, soothing look that invites quiet contemplation and rich, warm memories.

Available for Clear Front 75X65, Clear Three Sided 75H in NG only

Clear 75X65  
with Chopped Light  
Burning Logs





Clear 75H with Dark  
Burning Logs

# ABOUT US



Fireplaces add comfort and warmth to any home. They can also be a striking architectural addition, becoming a focal point of the space.

Ortal, founded in 1986, has gained global recognition for its extensive selection of modern gas fireplaces, produced with close attention to detail, finishing and quality. Our products combine traditional and modern design with technological innovations that make them eco-friendly with high heating efficiency ratings. Stunning fireplaces that are safe, beautiful and very effective is made possible with our proprietary advanced technology, which also allows you to install our fireplaces where others cannot.

Ortal's modern fireplaces are available in an array of sizes to suit various designs and architectural needs.

We also welcome your vision for custom-made fireplaces, addressing any special requirements, size and use. Our high quality fireplaces are CSA and CE certified and our dealers are committed to provide you service and installation excellence.

## THE ARCHITECTS' CHOICE



KRISTI WATTS

"That's the beautiful thing with the Ortal, they create fireplaces that can be an open element, but yet still kind of a division that is fun to design around."



MARCUS GLEYSTEEEN

"We love using Ortal. As yet, I don't think they have much in the way of competition, in terms of developing something that is as clean and simple, as crisp as their product."

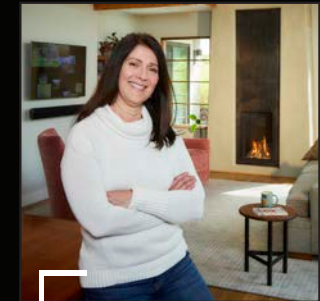

TALI HARDONAG

"Ortal's units appeal to me more than others because they can be incorporated into the design that I need"





Open haarden voegen comfort en warmte toe aan elk huis. Ze kunnen ook een opvallende architectonische toevoeging zijn, en de blikvanger worden van de ruimte.

Ortal werd in 1986 opgericht en heeft wereldwijde erkenning gekregen voor zijn uitgebreide aanbod van moderne gashaarden, gemaakt met de grootste aandacht voor de details, afwerking en kwaliteit. Onze producten combineren traditionele en moderne designs met technologische innovaties die ze milieuvriendelijk maken maar ook een zeer efficiënte verwarming garanderen. Prachtige open haarden veilig, mooi en buitengewoon effectief dankzij onze eigen geavanceerde technologie, die u ook de mogelijkheid biedt om onze producten te installeren op plaatsen waar andere open haarden uitgesloten zijn. De moderne open haarden van Ortal zijn verkrijgbaar in een waaier van formaten die aansluiten op de uiteenlopende design - en architectonische behoeften.

Wij maken ook open haarden op maat voor alle bijzondere behoeften in termen van afmetingen en toepassingen. Onze hoogwaardige open haarden zijn CSA- en CE-gecertificeerd en onze dealers leveren u een uitstekende service en installatiediensten.

**GROENE VERKLARING:** Ortal presenteert een groene, milieuvriendelijke oplossing voor de moderne tijd. Dankzij de hoogefficiënte prestaties en de eigentijdse designs van Ortal hoeft u de vorm niet op te offeren aan de functie. Het unieke design van Ortal maximaliseert de stralingswarmte van de haard. Andere efficiënte componenten zijn de directe ventilatietechnologie van Ortal, de elektronische ontsteking (in plaats van een waakvlam) en de beperkte onderhoudseisen.



Kamine geben dem Zuhause Gemütlichkeit und Wärme. Sie können außerdem als eindrucksvolle architektonische Ergänzung dienen und zum Mittelpunkt eines Raumes werden.

Ortal wurde im Jahre 1986 gegründet und hat seither durch die umfangreiche Auswahl an modernen Gaskaminen, die mit großer Sorgfalt in Sachen Detail, Qualität und Perfektion gefertigt werden, globale Anerkennung erlangt. Unsere Produkte verbinden traditionelle und moderne Designs mit technologischen Innovationen, wodurch sie umweltfreundlich sind und eine hohe Heizungseffizienz erreichen. Die Herstellung unserer sicheren, wunderschönen und hocheffizienten Kamine ist durch unsere eigene fortschrittliche Technik möglich gemacht, die es Ihnen erlaubt, unsere Kamine dort einzubauen, wo andere nicht zu platzieren sind

Moderne Kamine von Ortal sind in verschiedenen Größen verfügbar und können an das vorhandene Design und an die architektonischen Gegebenheiten vor Ort angepasst werden.

Für Sonderanfertigungen nach Ihren persönlichen Vorstellungen und Wünschen unterbreiten wir Ihnen gerne ein individuelles Angebot. Unsere hochwertigen Kamine sind nach CSA und CE zertifiziert. Unsere Partner und Händler bieten ebenfalls erstklassigen Service bei Wartung und Installation.

## THE ARCHITECTS' CHOICE



MICHAEL RUSSELL

"I think the wonderful thing that Ortal has offered, is a more contemporary point of view of design, that gives you a lower and sleek look"

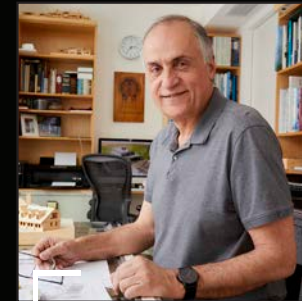

TASOS KOKORIS

"Ortal's shapes are very conducive to modern architecture. I can get them very long, narrow, so even if you are behind the furniture, you'll see the flame."



TREFF LAFLECH

"Ortal is particularly fascinated with their collaboration with architects and designers. They have given us incredible flexibility to create fireplaces that are expressive sculptural components that the entire room gathers itself around."





**ES** También pueden ser una sorprendente adición arquitectónica, convirtiéndose en un punto focal del espacio



Ortal, fundada en 1986, ha ganado reconocimiento mundial por su extensa selección de modernas chimeneas a gas, producidas con gran atención al detalle, acabado y calidad. Nuestros productos combinan el diseño tradicional y moderno con innovaciones tecnológicas que los hacen amigables al ambiente con altas calificaciones de eficiencia de calefacción. Sorprendentes chimeneas que son seguras, hermosas y muy efectivas son hechas posibles con nuestra tecnología avanzada exclusiva, la cual también le permite instalar nuestras chimeneas donde otros no pueden.

La extensa selección de modernas chimeneas de Ortal es la más grande en Norteamérica y están disponibles en gran variedad de tamaños, para adaptarse a diversas necesidades arquitectónicas y de diseño.

También damos la bienvenida a su visión para chimeneas a la medida, tratando cualquier requerimiento, tamaño y uso especiales. Nuestras chimeneas de alta calidad están certificadas CSA y CE, y nuestros vendedores están comprometidos a proporcionarle excelencia de servicio e instalación.

**DECLARACIÓN VERDE:** Ortal ofrece una solución de calefacción verde y amigable al ambiente para la era moderna. Con las altas calificaciones de eficiencia y diseños contemporáneos de Ortal, usted no tiene que sacrificar forma por función. El diseño exclusivo de Ortal maximiza el calor radiante de la chimenea. Componentes eficientes adicionales incluyen el uso por Ortal de tecnología de ventilación directa (en lugar de un piloto) y bajos requerimientos de mantenimiento.

# FRONT FACING

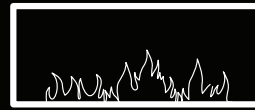

**EN** Our front-facing fireplaces can be beautifully integrated into walls and architectural elements.

**NL** Onze frontale haarden kunnen prachtig worden opgenomen in wanden en architectonische elementen.

**DE** Unsere nach vorne gerichteten Kamine können auf wunderbare Art in Wände und architektonische Elemente integriert werden.

**ES** Nuestras chimeneas con vista al frente pueden ser bellamente integradas en paredes y elementos arquitectónicos.

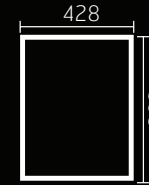

**Clear 40**

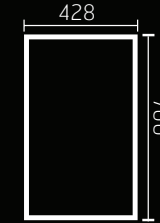

**Clear 40\*70**

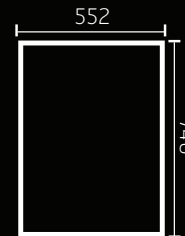

**Clear 60\*80**

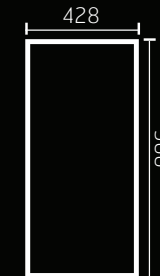

**Clear 40\*90**

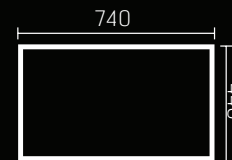

**Clear 75**

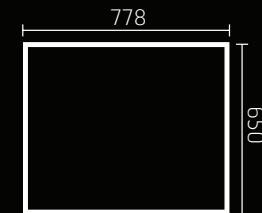

**Clear 75\*65**

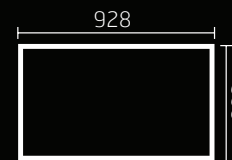

**Clear 90**

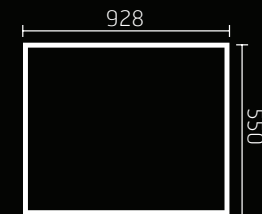

**Clear 90H**

\* For complete drawings please check our website

# VIEWING AREA DIMENSIONS

FRONT FACING 

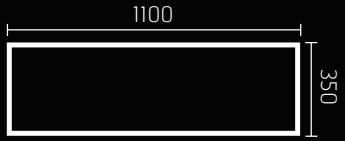

**Clear 110**

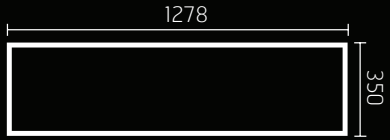

**Clear 130**

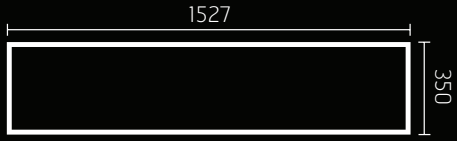

**Clear 150**

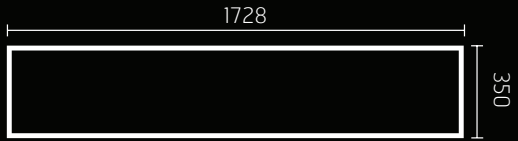

**Clear 170**

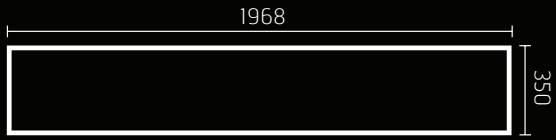

**Clear 200**

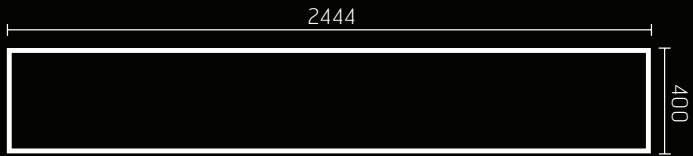

**Clear 250**

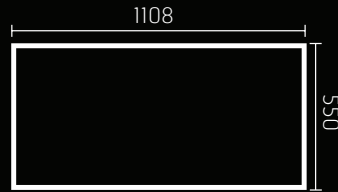

**Clear 110H**

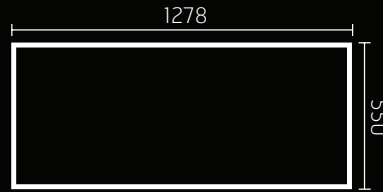

**Clear 130H**

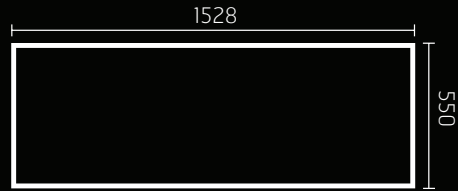

**Clear 150H**

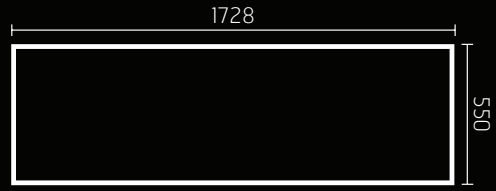

**Clear 170H**

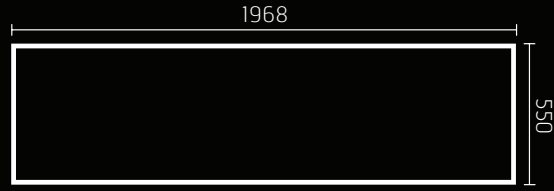

**Clear 200H**

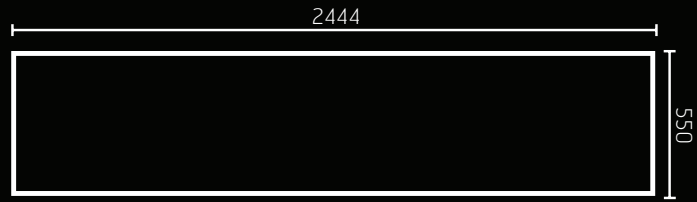

**Clear 250H**



Clear 40H70  
California



Clear 75X65  
California

## REDISCOVER FIRE

Unlimited Design Possibilities,  
Clean Line and Endless Options





Clear 250

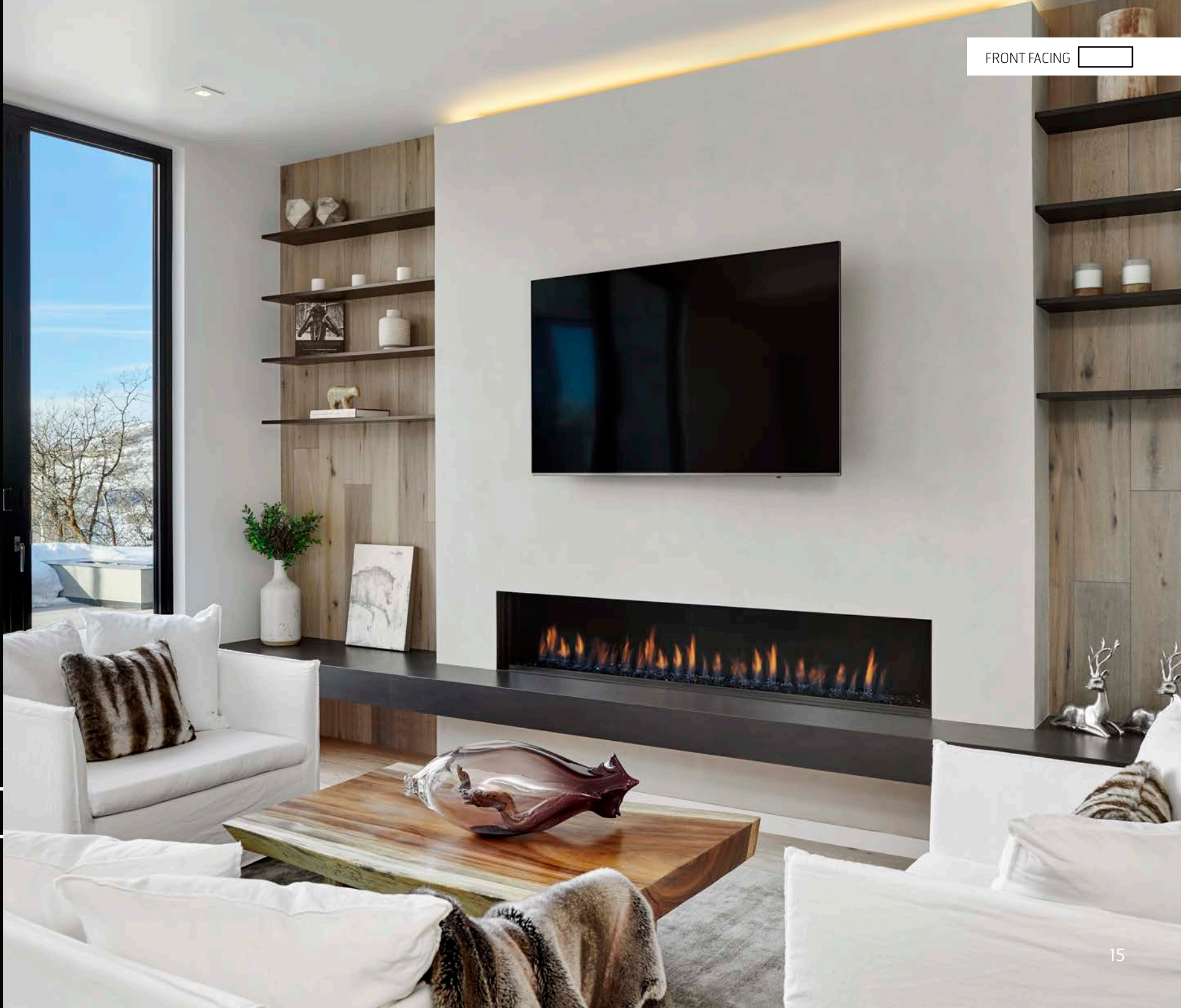

Clear 200  
California



# CORNER



**EN** Wide or narrow, cozy or imposing, corner fireplaces are an ideal and flexible architectural solution.

**NL** Breed of smal, knus of imasant: onze hoekhaarden zijn een ideale en flexibele architectonische oplossing.

**DE** Ob breit oder schmal, gemütlich oder imasant, Kaminecken sind eine ideale und flexible architektonische Lösung.

**ES** Anchas o estrechas, íntimas o imponentes, las chimeneas de esquina son una solución arquitectónica ideal y flexible.

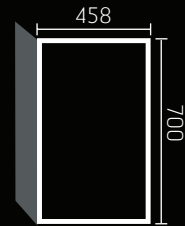

**Clear 40+70**

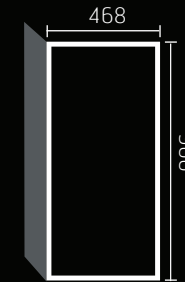

**Clear 40+90**

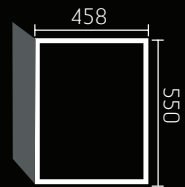

**Clear 40**

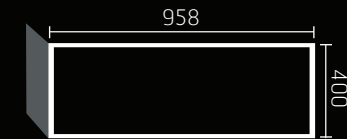

**Clear 90**

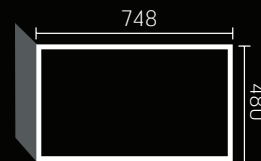

**Clear 75**

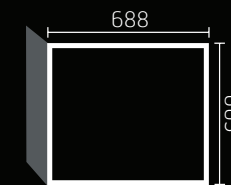

**Clear 75H**

\* For complete drawings please check our website

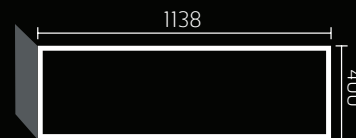

**Clear 110**

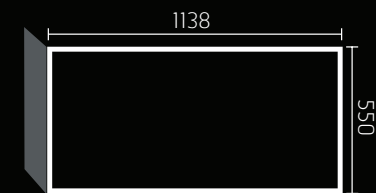

**Clear 110H**



# VIEWING AREA DIMENSIONS

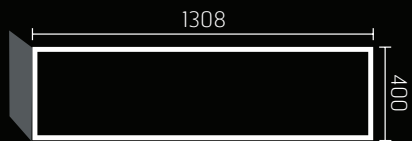

**Clear 130**

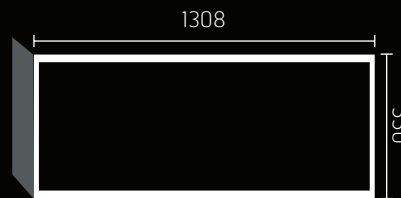

**Clear 130H**

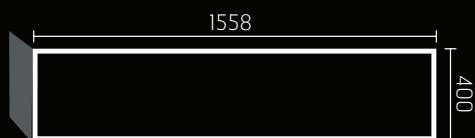

**Clear 150**



**Clear 150H**

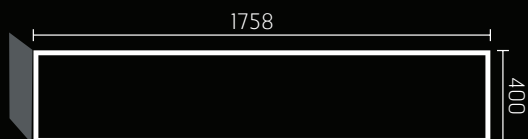

**Clear 170**

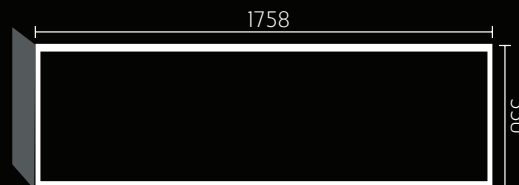

**Clear 170H**

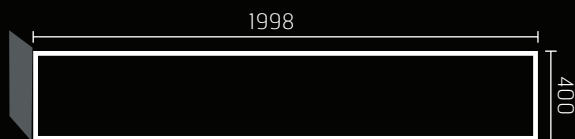

**Clear 200**

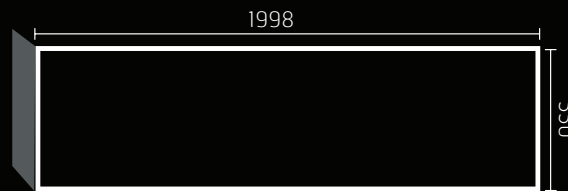

**Clear 200H**

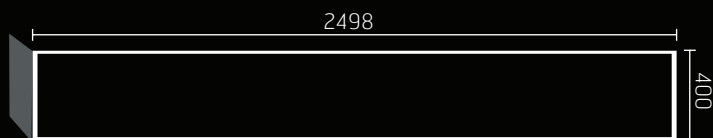

**Clear 250**

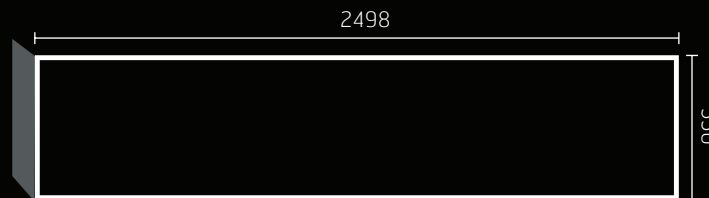

**Clear 250H**

## REINVENT FIRE

Ortal combines classic beauty with innovative technology to transform every fireplace into a modern masterpiece

Clear 110 LS  
California





Clear 130 RS  
Massachusetts



Clear 200 LS

Clear 130 RS Double Glass  
California



# THREE SIDES



**EN** Big or small, our built-in, three-sided fireplaces are architecturally stunning elements that can be enjoyed from different angles and spaces.

**NL** Groot of klein, onze ingebouwde driezijdige haarden zijn architectonisch verbluffende elementen, even mooi uit elke invalshoek en in elke ruimte.

**DE** Ob groß oder klein, unsere eingebauten dreiseitigen Kamine sind architektonisch umwerfend, da die verschiedenen Elemente von verschiedenen Winkeln und Räumen bewundert werden können.

**ES** Grandes o pequeñas, nuestras chimeneas de tres lados son elementos arquitectónicamente sorprendentes que pueden ser disfrutados desde diferentes ángulos y espacios.

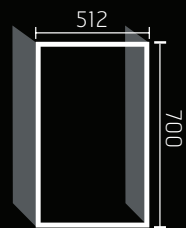

**Clear 40+70 TS**

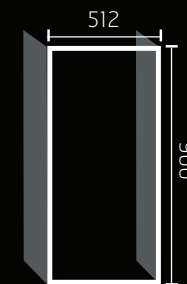

**Clear 40+90 TS**

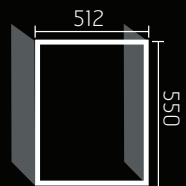

**Clear 40 TS**

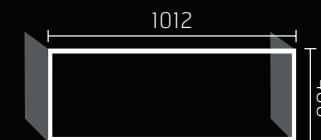

**Clear 90 TS**

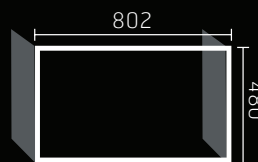

**Clear 75 TS**

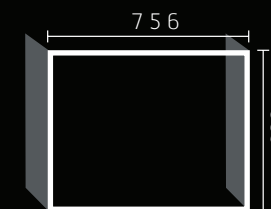

**Clear 75H TS**

\* For complete drawings please check our website

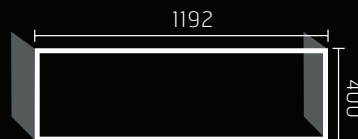

**Clear 110 TS**

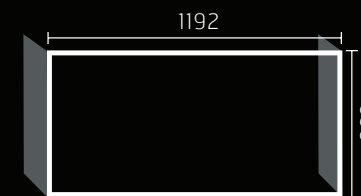

**Clear 110H TS**

# VIEWING AREA DIMENSIONS

THREE SIDES 

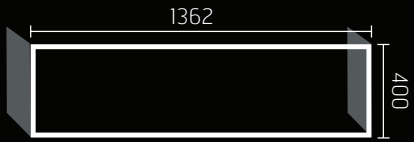

**Clear 130 TS**

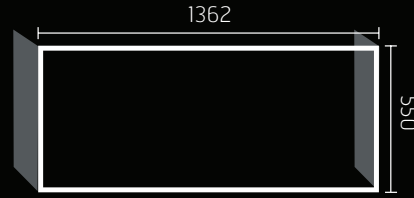

**Clear 130H TS**

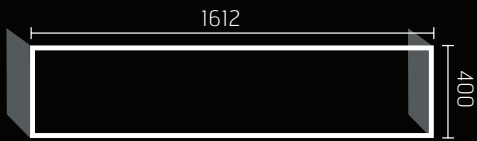

**Clear 150 TS**

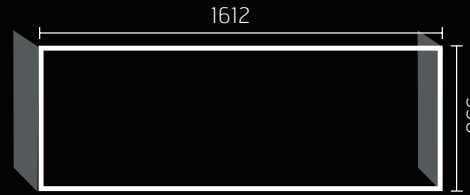

**Clear 150H TS**

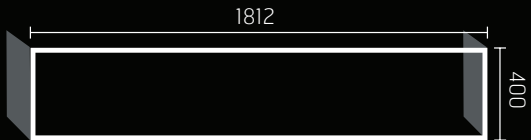

**Clear 170 TS**

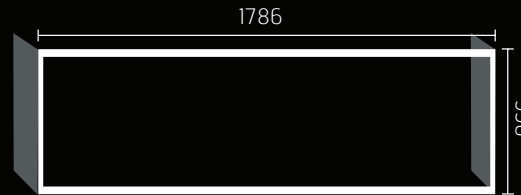

**Clear 170H TS**

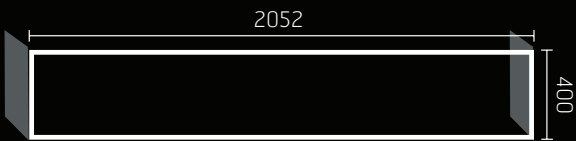

**Clear 200 TS**

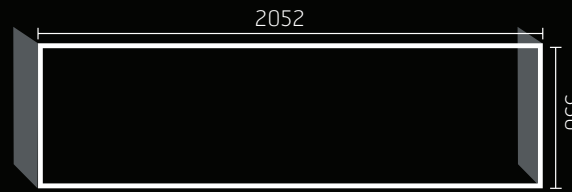

**Clear 200 H TS**

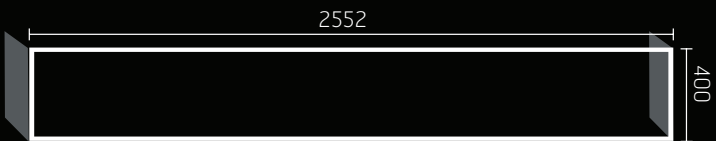

**Clear 250 TS**



**Clear 250H TS**





Clear 170 TS  
California



Clear 75H TS



Clear 200 TS  
New York

Clear 200  
California





# SPACE CREATOR

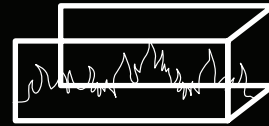

**EN** Ortal's Space Creator is a unique way to separate living spaces, yet combine them visually.

**NL** De Space Creator van Ortal is een unieke manier om woonruimten te scheiden en toch een visuele band te scheppen.

**DE** Ortals Space-Creator ist eine besondere Art und Weise, Wohnflächen aufzuteilen und sie gleichzeitig visuell zu verbinden.

**ES** El Space Creator de Ortal es una forma única de separar espacios de vida y a la vez combinarlos visualmente.

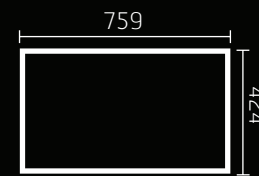

**Space Creator 75**

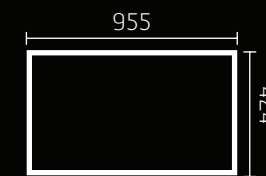

**Space Creator 90**

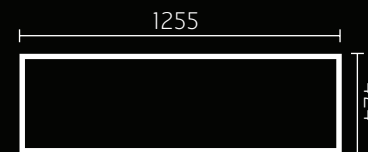

**Space Creator 120**

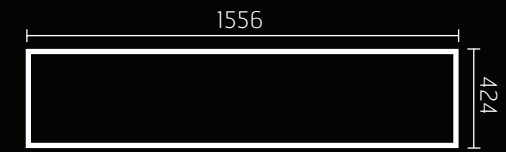

**Space Creator 150**

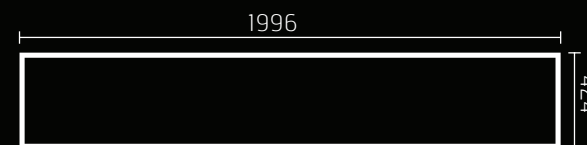

**Space Creator 200**

\* For complete drawings please check our website

Space Creator 120  
California



## RETHINK FLEXIBILITY

Ortal gives you the flexibility to design an extraordinary fireplace into any project



Space Creator 150  
Double Glass  
California









Space Creator 200  
Utah

# TUNNEL



**EN** Tunnel fireplaces are visible from both sides while encased in walls or columns. They can be used to divide a living space or to enjoy the warmth and beauty of the flames in two separate rooms. This style can also be used as an indoor/outdoor fireplace.

**NL** Tunnelhaarden worden in wanden of kolommen ingebouwd en zijn aan beide zijden zichtbaar. Ze kunnen worden gebruikt om een woonruimte te verdelen en in de twee afzonderlijke kamers van de warmte en schoonheid van de vlammen te genieten. Ze kunnen ook worden gebruikt als haard voor binnen en voor buiten.

**DE** Tunnel-Kamine sind von beiden Seiten sichtbar und von Wänden oder Säulen eingeschlossen. Sie sind dabei nützlich, einen Wohnraum aufzuteilen oder die Wärme und Schönheit der Flammen in zwei separaten Räumen zu genießen. Dieser Stil kann außerdem für einen Innen-Außenkamin benutzt werden.

**ES** Las chimeneas de túnel son visibles desde ambos lados a la vez que están encerradas en paredes o columnas. Pueden ser usadas para dividir un espacio de vida o para disfrutar la calidez y belleza de las llamas en dos habitaciones separadas. Este estilo puede también utilizarse como chimenea de interiores/exteriores.

\* For complete drawings please check our website

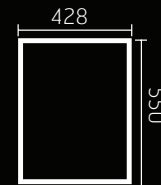

**Clear 40**

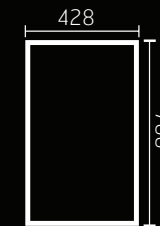

**Clear 40\*70**

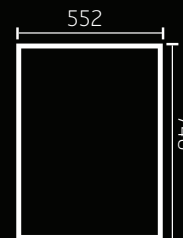

**Clear 60\*80**

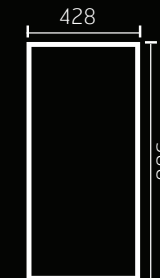

**Clear 40\*90**

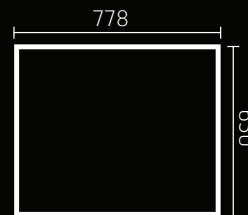

**Clear 75\*65**

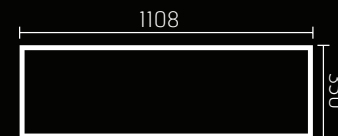

**Clear 110**



**Clear 110H**

# VIEWING AREA DIMENSIONS

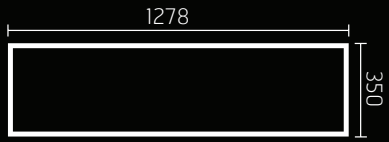

**Clear 130**

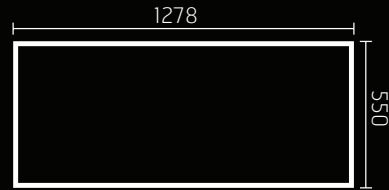

**Clear 130H**

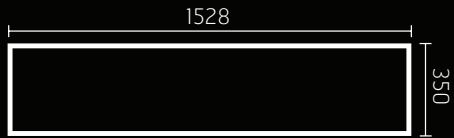

**Clear 150**

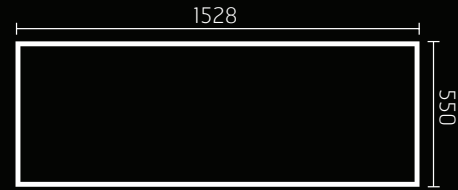

**Clear 150H**

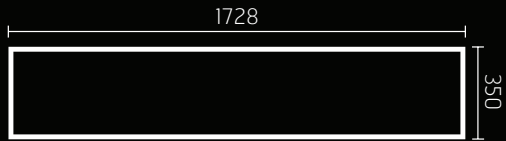

**Clear 170**

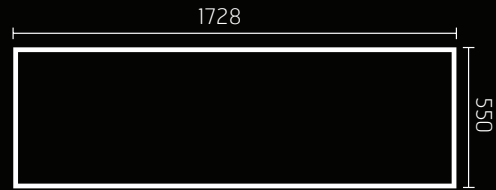

**Clear 170H**

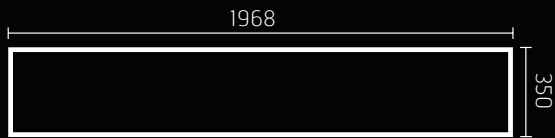

**Clear 200**

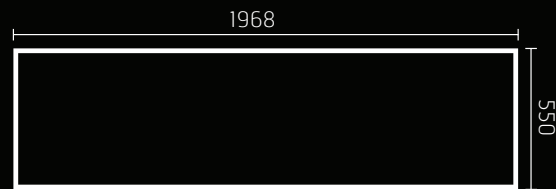

**Clear 200H**

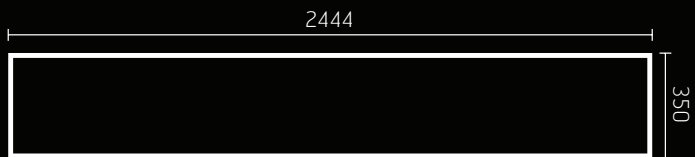

**Clear 250**

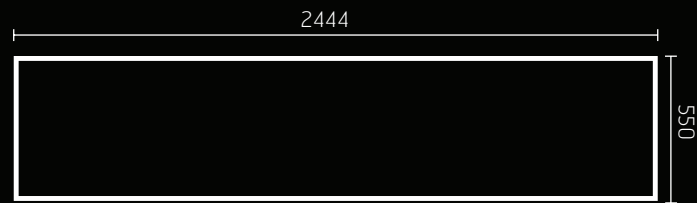

**Clear 250H**

## REKINDLE IMAGINATION

With Fan exhaust system for anywhere installation, Ortal lets you design dreams

Clear 75X65 Tunnel  
with Fan Exhaust  
California









Clear 150 TN  
California



Clear 170 TN  
Nevada

# INDOOR / OUTDOOR

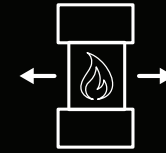

**EN** When placed in an exterior facing wall, these tunnel fireplaces can also be used as an indoor/outdoor fireplace doubling its functionality and extending its impact. Get warmth and ambience inside and outside at the same time.

**NL** Bij plaatsing in een buitenwand, kunnen tunnelhaarden ook gebruikt worden als een binnen-/ buitenhaard wat de functionaliteit verdubbelt en meer impact geeft. Creëer zowel binnen als buiten warmte en sfeer op hetzelfde moment.

**DE** Wenn dieser Tunnel-Kamin in einer Außenwand eingebaut wird kann er als kombinierter Innen-/Außenkamin verwendet werden, um einen noch besseren Eindruck zu erzielen. Wärme und Wohlbehagen im Innen- und Außenbereich gleichzeitig.

**ES** Cuando se colocan en una pared de vista al exterior, estas chimeneas de túnel también se pueden usar como chimenea de interior/exterior, duplicando su funcionalidad y extendiendo su impacto. Obtenga calidez y ambiente dentro y fuera al mismo tiempo.

\* For complete drawings please check our website

Indoor/ Outdoor 7.5m TN  
Beresheet Hotel, Israel



□ AVAILABLE IN ALL TUNNEL MODELS ABOVE SIZE 60

INDOOR / OUTDOOR 



INSIDE

Indoor/Outdoor 200 TN  
Los Angeles



# OUTSIDE



Indoor/Outdoor 200 TN  
Los Angeles

# STAND ALONE



6080 OVAL

**EN** Sometimes the best placement for a fireplace is as an individual artistic element within a living space. Ortal has an impressive variety of Stand Alone fireplaces which are ideal for remodels as they add minimum disruption.

**NL** Soms komt een open haard het mooist tot zijn recht als een individueel artistiek element in een woonruimte. Ortal heeft een indrukwekkende variëteit van vrijstaande haarden. Omdat ze weinig aanpassingen vereisen, zijn ze ideaal voor verbouwingen.

**DE** Manchmal ist die beste Stelle für einen Kamin ein individuelles künstlerisches Element innerhalb eines Wohnraums. Ortal hat eine beeindruckende Vielfalt an frei stehenden Kaminen, die Ideal für Umgestaltungen sind, da sie minimale Störungen verursachen.

**ES** A veces el mejor lugar para una chimenea es como un elemento artístico individual dentro de un espacio de vida. Ortal tiene una impresionante variedad de chimeneas autónomas, las cuales son ideales para remodelar pues añaden una perturbación mínima.

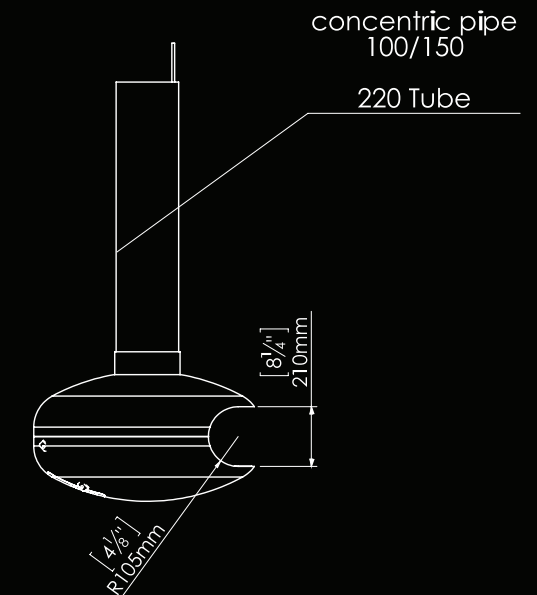
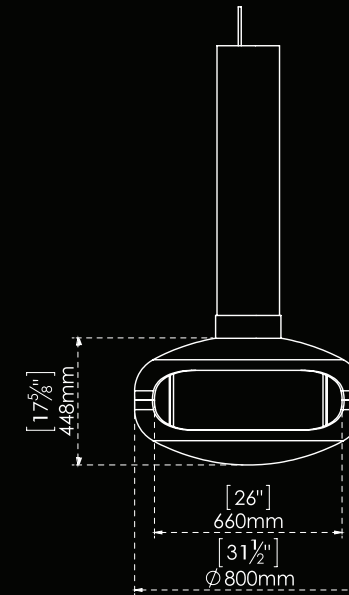



# OVAL 120 WALL MOUNTED

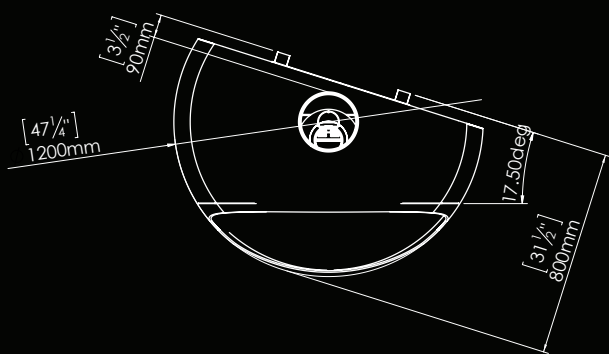
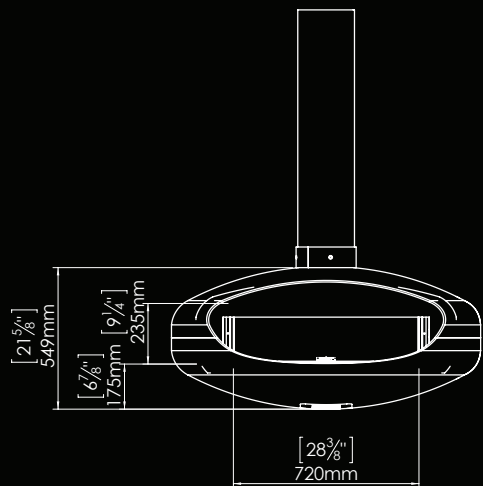

Available also as a hanging unit

STAND ALONE



# CLASSIC F80

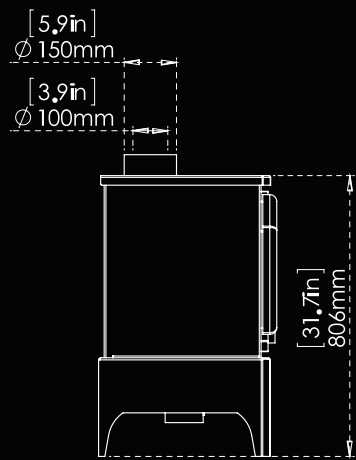
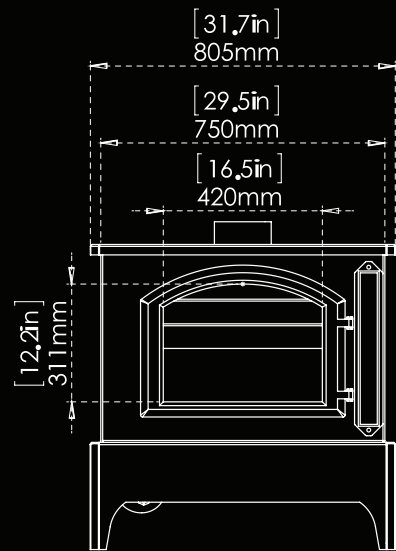



# CLASSIC CORNER

STAND ALONE

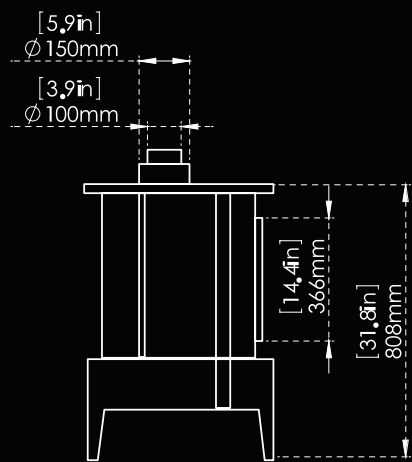
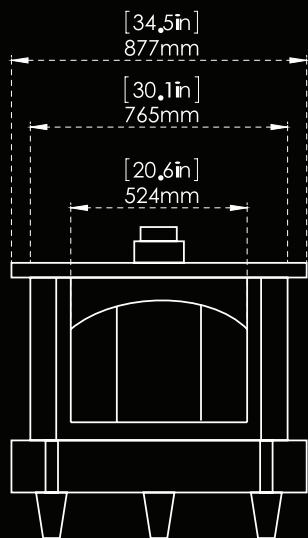

SMALL SQUARE

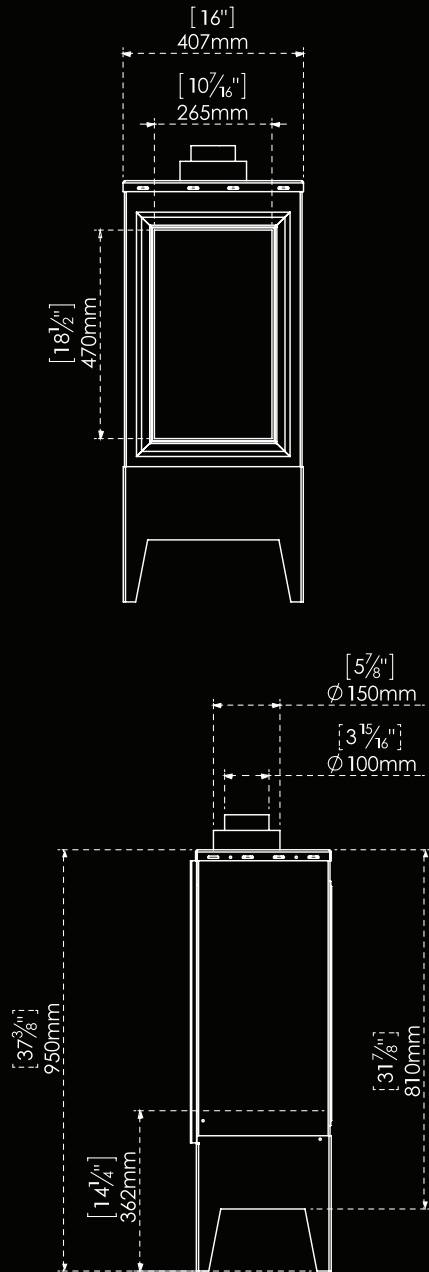





# MODERN CORNER

STAND ALONE

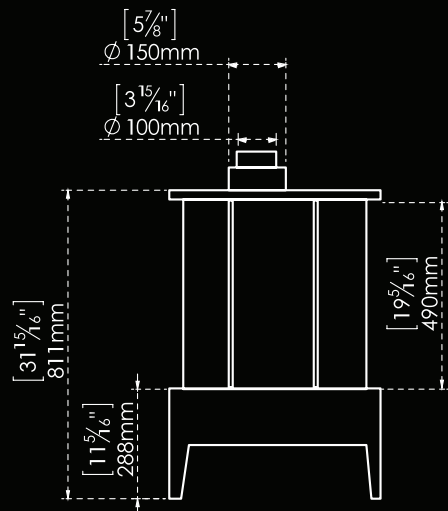
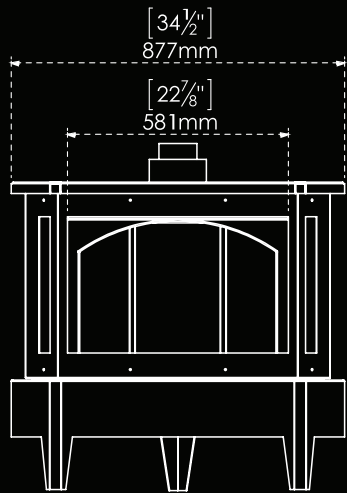



## STAND ALONE 75

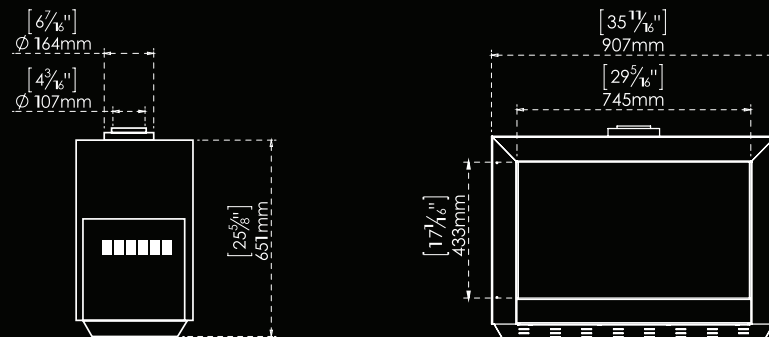

## STAND ALONE 110

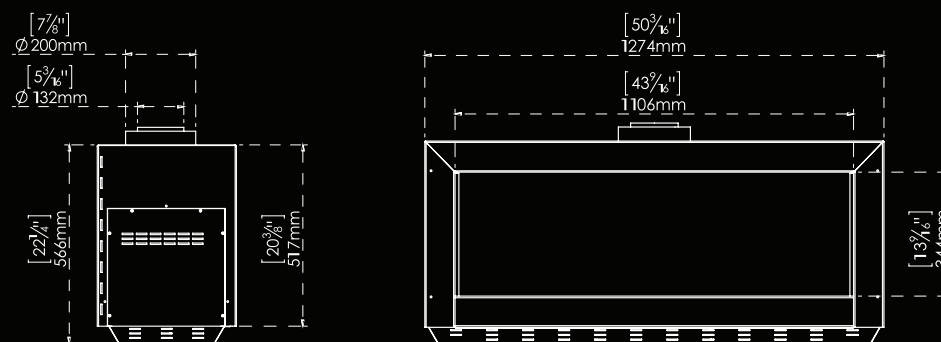

## STAND ALONE 150

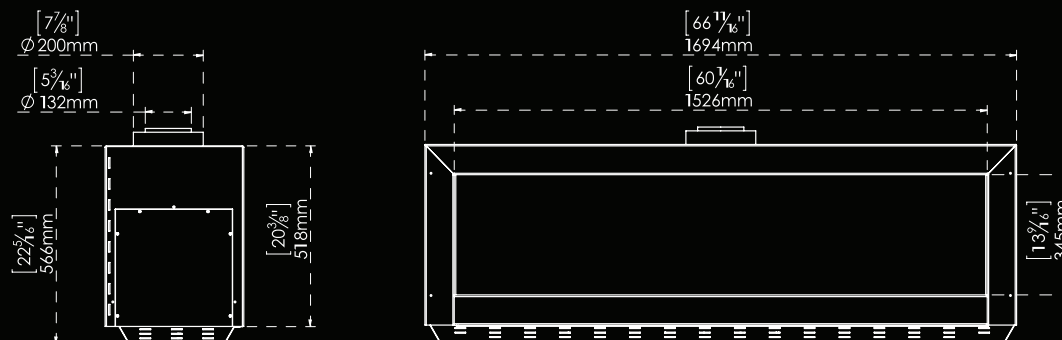

Stand Alone 150  
California





# STAND ALONE 40 TS

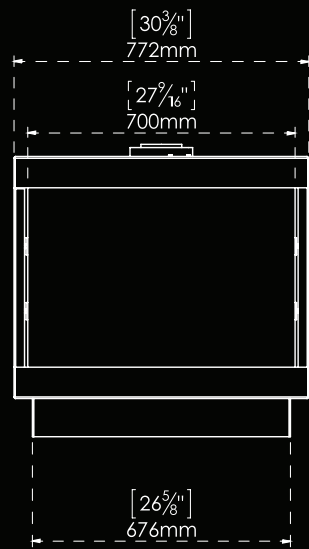
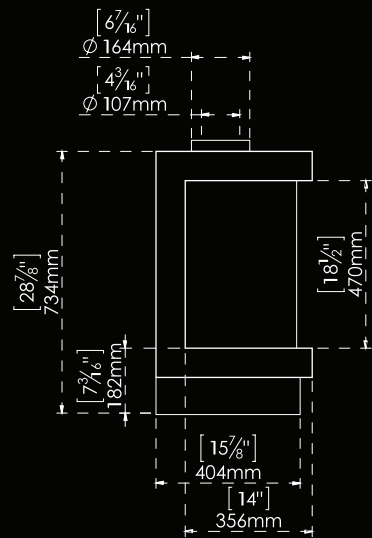



# STAND ALONE 75

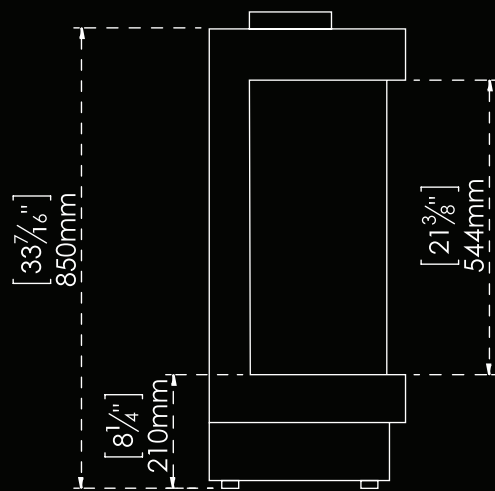
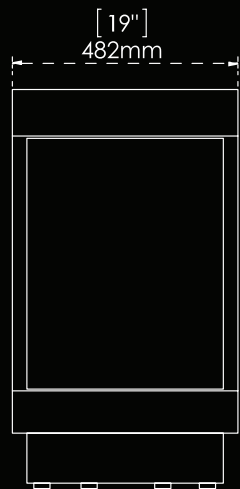

# ISLAND & CIRCLE

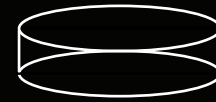

**EN** From every angle, these Fireplaces provide warmth and views. With the flexibility to place it anywhere in the room from center to side, it's a real design feature. Also available in two-thirds circular design when the perfect place for it is against the wall.

**NL** Deze open haarden bieden vanuit elke invalshoek warmte en een mooi zicht. De flexibiliteit om de haard zowel in het midden of aan de zijkant van de kamer te plaatsen, maakt het een echt decoratief element. Ook verkrijgbaar in twee derde cirkelvormig design voor als een wand de perfecte plek vormt voor de haard.

**DE** Diese Kamine bieten Wärme und Behaglichkeit in jeder Hinsicht. Das Design bietet eine hohe Flexibilität und ermöglicht eine zentrale oder seitliche Platzierung überall im Raum. Auch erhältlich im runden Zwei-Drittel-Design, das optimal direkt an der Wand platziert werden kann.

**ES** Desde cualquier ángulo, estas Chimeneas proporcionan calidez y vista. Con la flexibilidad de poder colocarla en cualquier parte de la habitación, en el centro o a un lado, es una verdadera característica de diseño. También están disponibles en diseño circular de dos tercios, cuando el lugar perfecto es contra la pared.

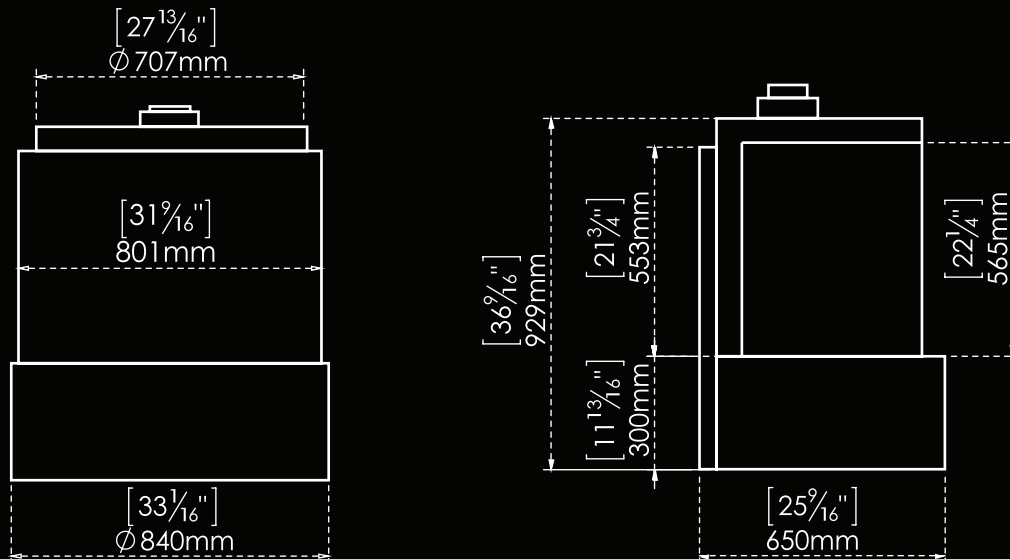









Circle 270  
flat hood

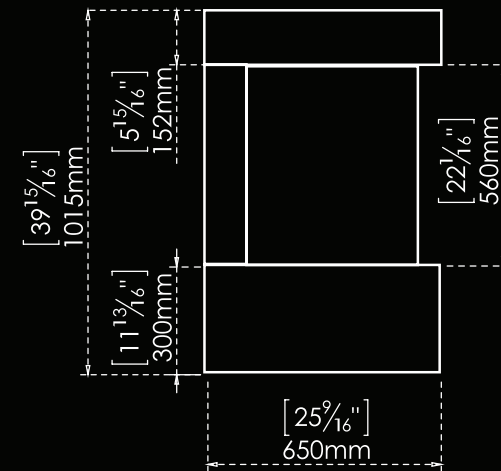
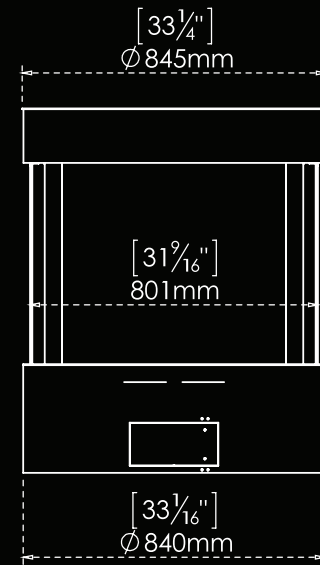

For information regarding hood options please check our sales department.

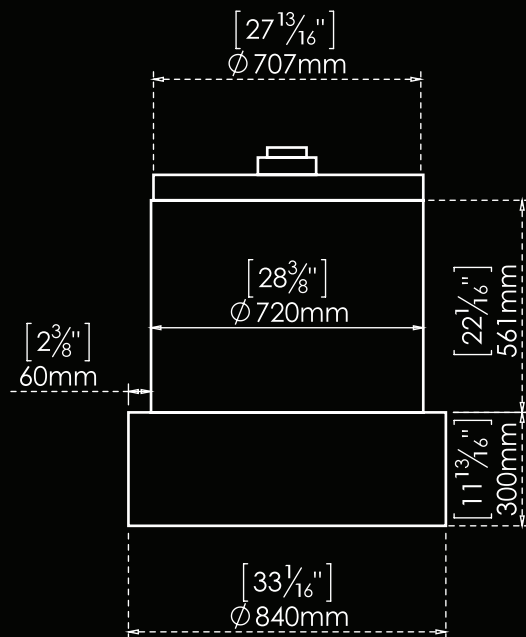



# COMMERCIAL



The world's most beautiful fireplaces plus start-to-finish planning and technical support. Ortal gives you the flexibility to design an extraordinary fireplace into any project.

Island 130 & Traditional 110 at a Congress Center in Quebec, Canada



# ADVANTAGES

## DESIGN



INTERIOR DECORATION  
64-67



LIGHTING ELEMENTS  
70

**150+**

OVER 150 MODELS  
82-85

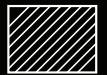

GRANITE PANELS  
68-69

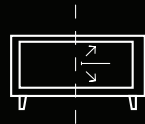

ANTI REFLECTIVE GLASS  
71

## TECHNOLOGY

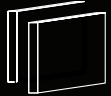

HEAT BARRIER SOLUTIONS  
72-73



TURBO HEATING  
76-77



DUAL-LINE BURNER  
79



FAN EXHAUST SYSTEM  
74-75



OPERATION CONTROL  
78



MODULAR  
80-81

# INTERIOR DECORATION

## LOGS & BRANCHES

**EN** Fireplaces can be delivered with a choice of media: Log Set, Branch Set, Ceramic stones and glass in a variety of color options. Other media approved for use in these appliances can be substituted after market. Please visit our website to view our range of state-of-the-art media and logs.

**NL** Haarden zijn leverbaar met uiteenlopende aankledingen: houtblokken, takken, keramische stenen en glas in diverse kleuren. Andere voor gebruik met deze toestellen goedgekeurde aankledingen kunnen achteraf worden geïnstalleerd. Bezoek onze website voor onze geavanceerde aankledingen en blokken.

**DE** Kamine können mit einer Auswahl an Medien geliefert werden: Rundholz-Set, Ast-Set, Keramiksteine und Glas in verschiedenen Farbvarianten. Andere Medien, die für den Gebrauch an diesen Einrichtungen zugelassen sind, sind im Fachhandel erhältlich. Las chimeneas se pueden entregar con una variedad de

**ES** medios: Juego de Troncos, Juego de Ramas, Piedras cerámicas y vidrio en varias opciones de color. Otros medios aprobados para uso en estos aparatos pueden ser sustituidos luego de la compra. Visite nuestro sitio web para ver nuestra gama de modernos medios y troncos.







**Bonfire Logs w/ Black Embers**  
**(11 pcs log set)**  
SKU: MYIEULS



**Long or Short Branches**  
**w/ Beige Embers**  
SKU: Short - MLENS / Long - MLENL



**Refractory Clay Log Set w/ Beige Embers**  
**(6pcs per log)**  
SKU: MLRL



**Standard Log Set w/ Beige Embers**  
**(5pcs per log)**  
SKU: MLLG



**Aspen Logs**  
**(5 pcs log set)**  
SKU: MFOBL



**Campfire Logs**  
**(6 pcs log set)**  
SKU:MLCRLHR



**Weathered Driftwood Log Set w/ Black Embers**  
**(5pcs per log)**  
SKU: MLRCL



**Charred Branches**  
**(3 pcs log set)**  
SKU: MFOCL

# STONES & GLASS



**Silverstone**  
(10 pcs per set)  
SKU: MFOPG



**Ancient Amber**  
(1 kg per bag)  
SKU: MLCO



**Large Gray Pebble Set**  
(24 pcs per set)  
SKU: MLPBG



**Polished Obsidian**  
(1 kg per bag)  
SKU: MLCB



**Small White Pebble Set**  
(50 pcs per set)  
SKU: MLSTW



**Royal Colbalt**  
(1 kg per bag)  
SKU: MLCL



**Speckled gray pebbles**  
(10 pcs per set)  
SKU: MLPBG



**Small Gray Pebble Set**  
(50 pcs per set)  
SKU: MLSTG



**Large White Pebble Set**  
(24 pcs per set)  
SKU: MLPBW



**Brilliant Ice**  
(1 kg per bag)  
SKU: MLCC

## □ BRICKS & PANELS



Blackridge Narrow \*



Black Reflective Panel



Red Brick Panel \*\*

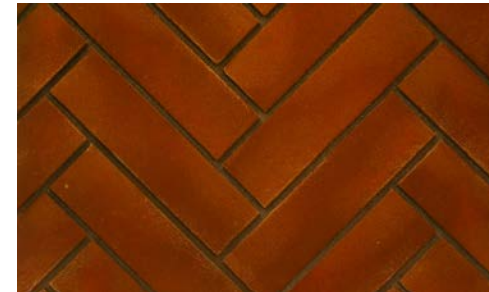

Red Herringbone Brick \*\*

\* Available for Clear 75X65 only

\*\* Available for Traditional models  
and Clear 75X65

# LIGHTING ELEMENTS



**EN** With internal lighting, you'll be able to extend your fireplace's appeal regardless if its in use. Built-in, recessed lighting are controlled with your remote, adding ambiance all of the time.

**NL** Met interne verlichting kunt u het mooie uiterlijk van uw open haard nog beter tot uiting brengen, ongeacht of deze wordt gebruikt. Ingebouwde, verzonken verlichting wordt met uw afstandsbediening geregeld en voegt op elk moment sfeer toe aan de ruimte.

**DE** Die interne Beleuchtung unterstreicht die Wirkung des Kamins auch dann, wenn dieser nicht in Betrieb ist. Die integrierte eingelassene Beleuchtung wird über die Fernbedienung gesteuert.

**ES** Con iluminación interna, usted podrá aumentar el atractivo de su chimenea ya sea que esté en uso o no. Su iluminación empotrada integral es controlada con su control remoto, añadiendo ambiente todo el tiempo.



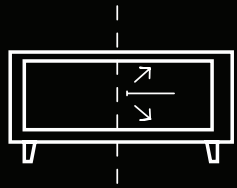

# ANTI REFLECTIVE GLASS

Anti Reflective

Reflective



# HEAT BARRIER SOLUTIONS

## IDEAL FOR COMMERCIAL SPACES AND YOUNG FAMILIES

**EN** Ortal's Double Glass and Screen solutions ensure that the temperature on a fireplace's outer glass layer is significantly reduced and safe to the touch. Ideal for high-traffic public venues such as hotels, restaurants or commercial spaces, both solutions create an innovative barrier that reduces the temperature of the fireplace's glass enclosure without impacting design. Supporting any type of fireplace, including front-facing, tunnel (see-thru) and multisided models, you'll have uncompromising safety and aesthetics.

**NL** De oplossingen met dubbel glas en scherm van Ortal zorgen ervoor dat de temperatuur op de buitenste glaslaag van de open haard sterk wordt gereduceerd en veilig is om aan te raken. Ideaal voor drukbezochte openbare locaties zoals hotels, restaurants of commerciële ruimtes, beide oplossingen creëren een innovatieve barrière die de temperatuur van de glazen behuizing van de haard reduceert zonder op het design in te boeten. Ondersteuning biedend aan elk type haard, inclusief frontale, tunnel - (doorkijk) en meerzijdige modellen, kunt u profiteren van onvoorwaardelijke veiligheid en esthetiek.

 Double Glass

78°C

215°C

**DE** Die Doppelverglasung von Ortal stellt eine deutliche Reduzierung der Temperatur an der äußeren Scheibe sicher, sodass diese gefahrlos berührt werden kann. Ideal für große Räume und Säle mit Publikumsverkehr, zum Beispiel in Hotels, Restaurants oder Messehallen. Beide Lösungen schaffen eine innovative Barriere. Aus Sicherheitsgründen wird die Temperatur direkt am Glasgehäuse erheblich reduziert, ohne das Design zu beeinträchtigen. Sicherheit und Ästhetik haben bei allen Kamintypen oberste Priorität, ganz gleich, ob Sie sich für ein Modell mit Frontscheibe, mit Tunnel (Durchblick) oder mit mehreren Seiten entscheiden.

**ES** Las soluciones de Doble Vidrio y Pantalla de Ortal aseguran que la temperatura en la capa exterior vidrio de una chimenea sea significativamente reducida y segura al tacto. Ideal para lugares públicos con alto tráfico, tales como hoteles, restaurantes o espacios comerciales. Ambas soluciones crean una innovadora barrera que reduce la temperatura de la caja de la chimenea sin afectar el diseño. Compatible con cualquier tipo de chimenea, incluyendo modelos de vista al frente, túnel y de lados múltiples, tendrá una seguridad y estética absolutas.

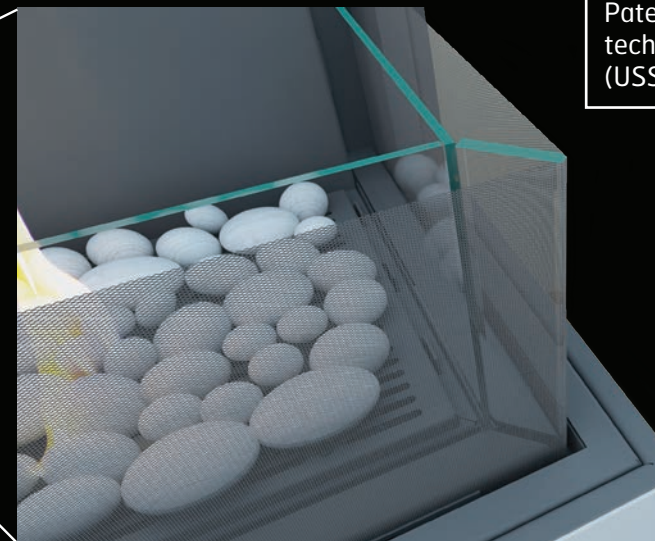

Screen Heat Barrier  
Patent-pending  
technology  
(USSN 60/040,074)

# FAN EXHAUST SYSTEM



**EN** Among the industry's most sophisticated, Ortal's Fan Exhaust System allows you to install our fireplaces in locations that conventional direct vent systems can't. The placement of the fireplace is no longer dependent upon the venting pathway. This system allows increased flexibility for locating the appliance inside the building.

**DE** Ortals Lüftungssysteme mit Kraftantrieb zählen zu den fortschrittlichsten der Branche und erlauben die Installation von Kaminen an Standorten, wo herkömmliche Lüftersysteme nicht anzubringen wären. Die Platzierung des Kamins ist nicht mehr von der Lage der Lüftung abhängig. Dieses System bietet hohe Flexibilität bei der Standortsuche der Vorrichtung im Gebäude.





**NL** Dankzij het ventilator uitlaatsysteem van Ortal, een van de meest geavanceerde op de markt, kunt u onze open haarden installeren op plaatsen waar een conventionele haard met directe ventilatie uitgesloten is. De plaats van de haard is niet langer afhankelijk van het rookkanaal. Dit systeem vergroot de flexibiliteit van de locatie van de haard in het gebouw.

**ES** Entre los más sofisticados de la industria, el Sistema de Ventilación Mecánica de Ortal le permite instalar nuestras chimeneas en lugares en los que no se puede instalar sistemas de ventilación directa convencional. La colocación de la chimenea ya no depende de la ruta de ventilación. Este sistema permite una mayor flexibilidad para ubicar el aparato dentro del edificio.

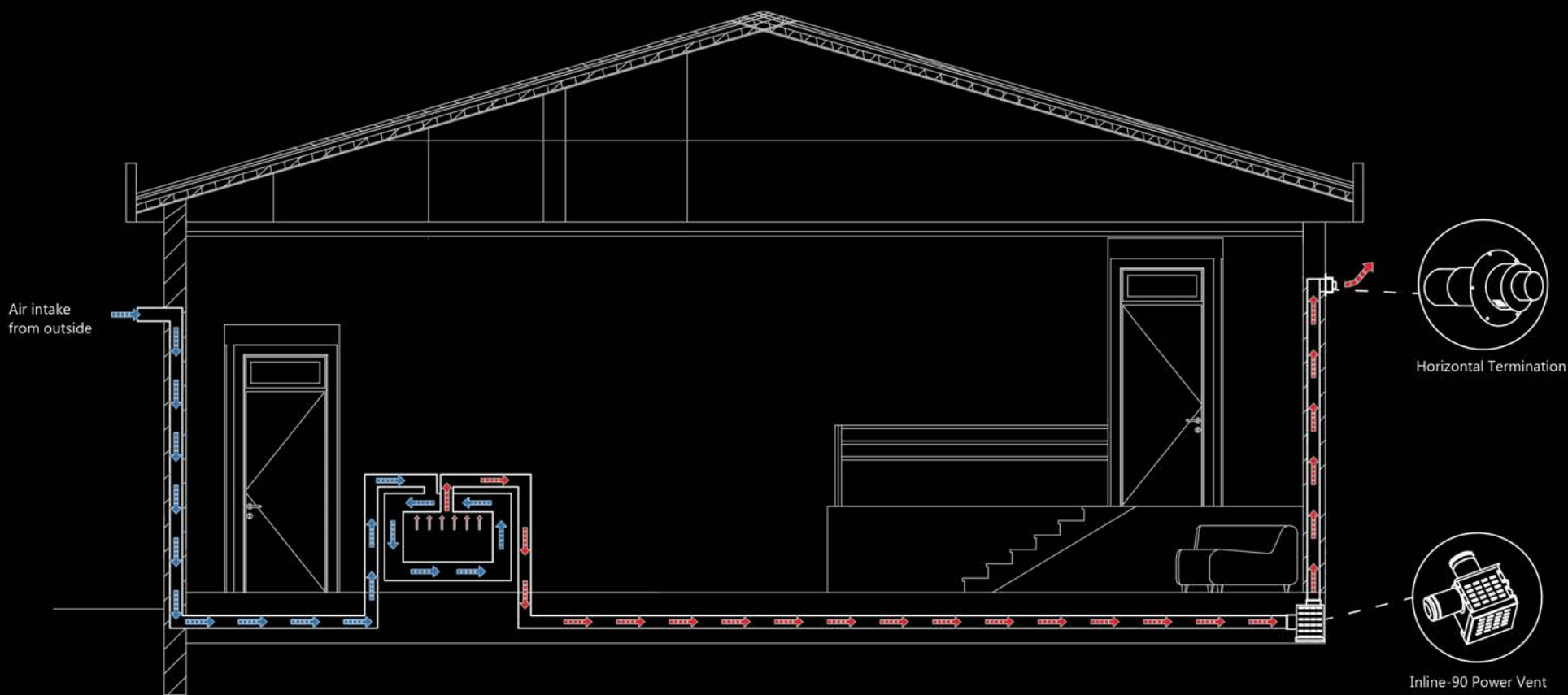

\*Available also with concentric pipes option

# TURBO HEATING



**EN** Maximize your fireplace's heating power. Blowers extract, rewarm and then distribute heated air throughout the interior, including to adjacent rooms. It's ideal for keeping large spaces consistently heated and warm.

**NL** Maximaliseer het verwarmingsvermogen van uw open haard. Blazers voeren verwarmde lucht af, warmen het opnieuw op en verspreiden het vervolgens in de ruimte en aangrenzende kamers. Ideaal om grote ruimtes doorlopend te verwarmen en warm te houden.

**DE** Maximieren Sie die Heizleistung Ihres Kamins. Mithilfe von Ventilatoren können Sie die erwärmte Luft im Innenraum verteilen und erneut aufheizen, einschließlich mehrerer Nebenzimmer. Ideal geeignet zum dauerhaften Beheizen großer Räumlichkeiten.

**ES** Maximice el poder de calefacción de su chimenea. Los sopladores extraen, recalientan y luego distribuyen el aire calentado por todo el interior, incluyendo habitaciones adyacentes. Es ideal para conservar espacios grandes consistentemente cálidos.

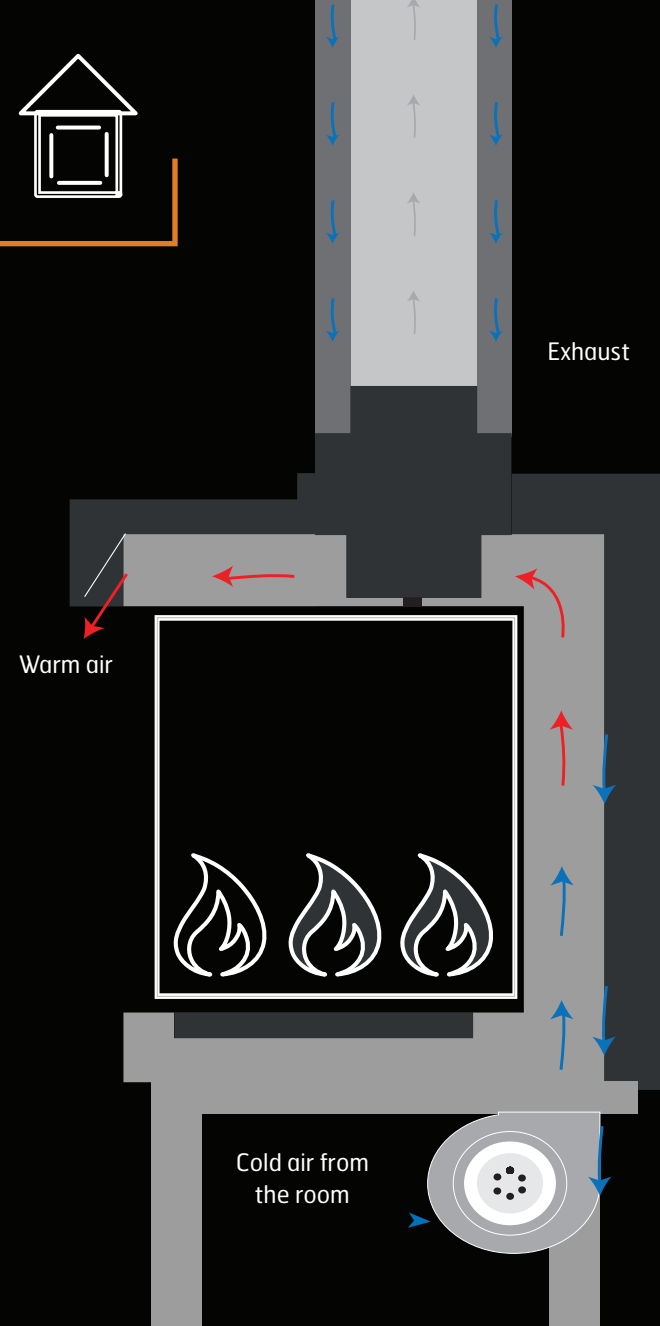

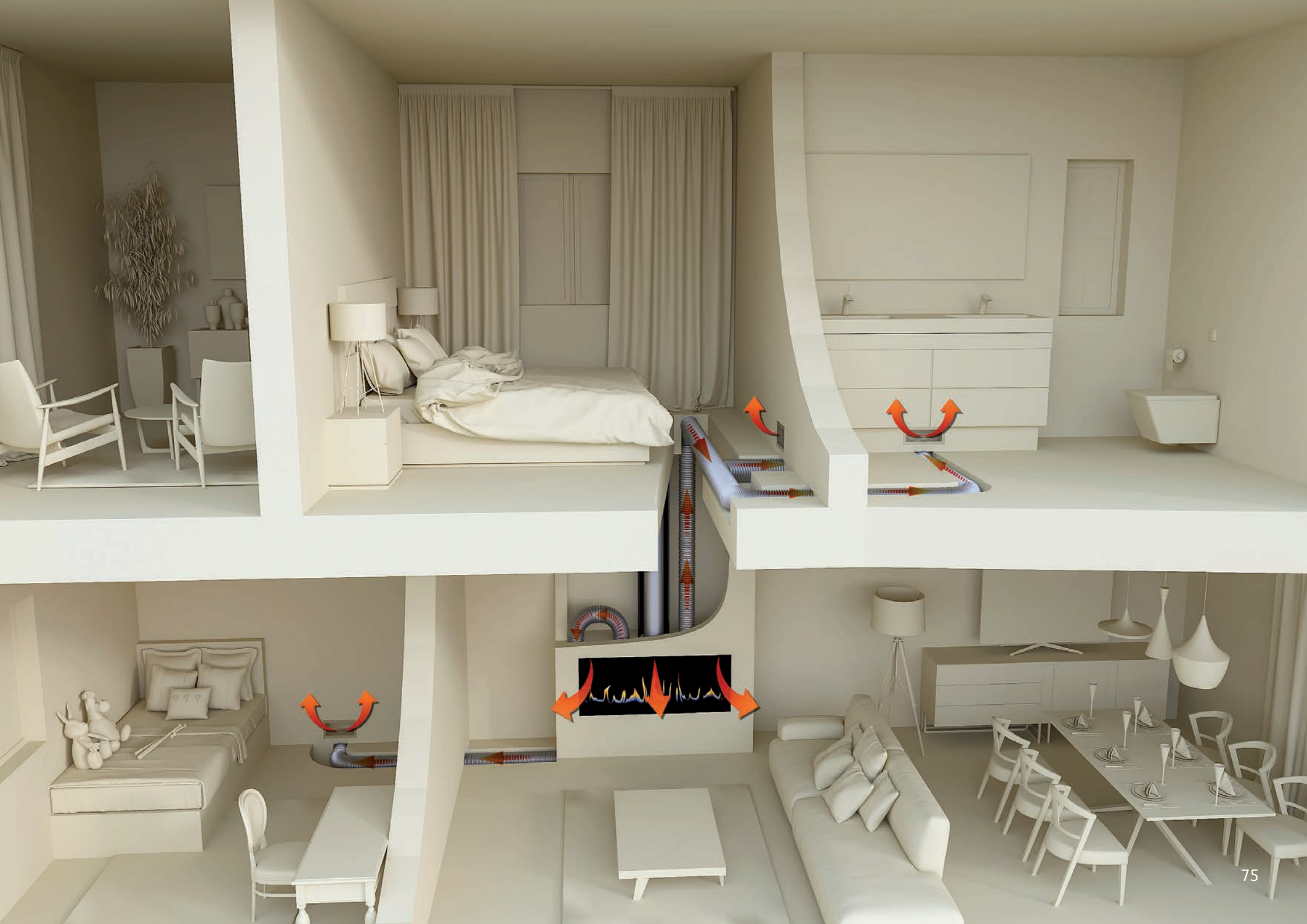

# OPERATION CONTROL OPTIONS

## NEW MYFIRE© APP

### MERTIK MAXITROL®

**EN** Ortal fireplaces include a remote control device that operates the pilot ignition, timer and thermostat as well as other optional features. Wall control units are also available, which can also be integrated into a smart house system. In addition you can also control your Ortal fireplace with the Symax© System from anywhere with the myfire© App.

**NL** De haarden van Ortal worden geleverd met een afstandsbediening voor de ontsteking, timer, thermostaat en andere optionele functies. Er zijn ook bedieningspanelen met wandmontage verkrijgbaar die zelfs in een domoticasysteem kunnen worden opgenomen. Daarnaast kunt u uw open haard met het Symax© System van overal bedienen met de myfire© App.

**DE** Ortal Kamine umfassen ein Fernbedienungsgerät, welches neben anderen Funktionen Zündflamme, Zeitschaltuhr und Thermostat bedient.

Wandbedienungseinheiten sind ebenfalls verfügbar, die auch in ein "Smart House" System integriert werden können. Zusätzlich können Sie Ihren Kamin von Ortal mit dem Symax© System von überall aus steuern, indem Sie die myfire© App verwenden.

**ES** Las chimeneas Ortal incluyen un dispositivo de control remoto que opera el encendido del piloto, cronómetro y termostato, así como otras características opcionales.

También hay disponibles unidades de control de pared, las cuales también pueden ser integradas en un sistema de casa inteligente. Además, puede controlar su chimenea Ortal con el Sistema Symax© desde cualquier parte, con la Aplicación myfire©.

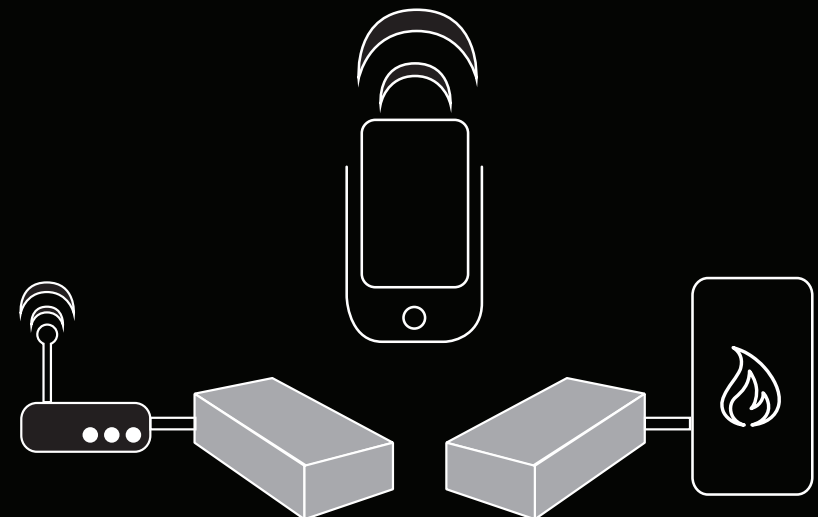

# DUAL-LINE BURNER



**EN** Ortal's dual line burner features two lines that can be controlled separately, ensuring the best visual effect and avoiding overheating. It is the only fire in the market that covers the full length of the fireplace even when working at a lower setting. When the two line burners are operated at full capacity, the room will be quickly heated. In warmer days the visual effect of the fire is preserved by operating just one line alongside the full length of the fireplace. The dual line burner is available in all models except clear 40 models.

**NL** De haard van Ortal met dubbele brander is voorzien van twee rijen die afzonderlijk regelbaar zijn, voor een prachtig visueel effect zorgen en oververhitting voorkomen. Het is de enige haard in de markt die over de volle lengte van de haard brandt, ook als de haard laag is ingesteld. Wanneer de twee rijen branders op volle capaciteit zijn ingesteld, zal de kamer snel warm worden. Op warmere dagen blijft het visuele effect van de haard bewaard door slechts één rij over de gehele lengte van de open haard aan te doen. Haarden met dubbele brander zijn verkrijgbaar in alle modellen behalve bij de clear 40 modellen.

**DE** Der Dualbrenner von Ortal unterstützt zwei getrennte Leitungen, die separat gesteuert werden können, um visuelle Effekte zu erzielen und eine Überhitzung zu vermeiden. Das ist der einzige am Markt erhältliche Kamin, der auch bei niedrigen Einstellungen über die komplette Länge befeuert wird. Wenn beide Leitungen des Brenners auf höchster Stufe betrieben werden, heizt sich der Raum schnell auf. An wärmeren Tagen bleibt der visuelle Effekt erhalten, indem eine der beiden Leitungen über die gesamte Länge des Kamins befeuert wird. Der Dualbrenner mit zwei Leitungen ist für alle Modelle mit Ausnahme von Clear 40 verfügbar.

**ES** El quemador de doble línea de Ortal presenta dos líneas que pueden ser controladas por separado, asegurando el mejor efecto visual y evitando el sobrecalentamiento. Es el único fuego en el mercado que cubre toda la longitud de la chimenea inclusive cuando trabaja en un ajuste más bajo. Cuando los quemadores de dos líneas son operados a plena capacidad, la habitación se calentará rápidamente. En días más cálidos, el efecto visual del fuego es preservado operando solamente una línea a todo lo largo de la chimenea. El quemador de doble línea está disponible en todos los modelos, excepto en los modelos clear 40.



# MODULAR FIREPLACES

## UNLIMITED LENGTH POSSIBILITIES

**EN** Ortal Modular Fireplaces can be seamlessly connected to create extended sizes and shapes affordably. You'll be able to create a custom fireplace, without the cost of customization.

**NL** Modulaire haarden van Ortal kunnen naadloos worden verbonden om grotere formaten en vormen op betaalbare wijze te creëren. Zo is het mogelijk een haard op A te maken, zonder aanpassingskosten.

**DE** Modulare Kamine von Ortal können nahtlos verbunden werden, um Größe und Form zu erweitern. Sie können Ihren Kamin selbst gestalten, ohne zusätzlichen Aufpreis.

**ES** Las Chimeneas Modulares de Ortal pueden ser conectadas sin problemas para crear formas y tamaños extendidos de manera asequible. Usted podrá crear una chimenea a la medida, sin el costo de la personalización.

\* Patent pending US 62/626,938

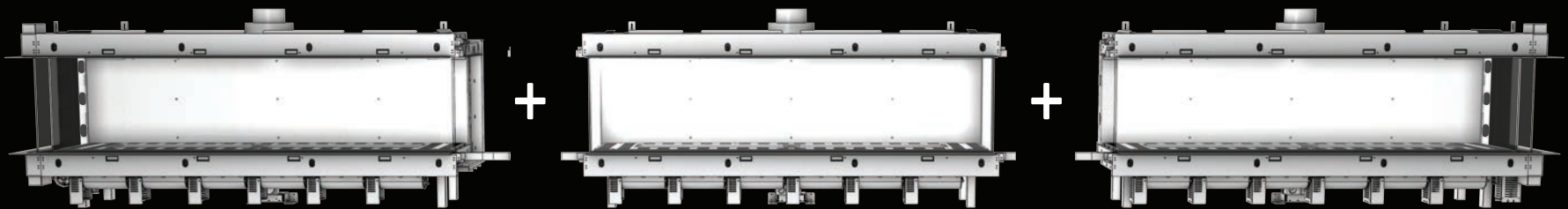



# OVER 150 MODELS

**EN** Ortal welcomes your clients' vision for custom-designed fireplaces responding to special requirements, sizes and uses. For technical specifications and more information, visit our website: [www.ortalheat.com](http://www.ortalheat.com)

**NL** Ortal staat open voor de wensen van uw klanten voor open haarden op maat van bijzondere eisen in termen van afmetingen en toepassingen. Raadpleeg voor technische specificaties en meer informatie onze website: [www.ortalheat.com](http://www.ortalheat.com)

**DE** Ortal nimmt gerne die Vorstellungen Ihrer Kunden für selbstentworfene Kamine entgegen und geht dabei auf spezielle Anforderungen und Größen/Nutzungsbedingungen ein. Besuchen Sie unsere Webseite für technische Spezifikationen und weitere Infos: [www.ortalheat.com](http://www.ortalheat.com)

**ES** Ortal da la bienvenida a la visión de sus clientes para Chimeneas diseñadas a medida, respondiendo a requerimientos, tamaños y usos especiales. Para especificaciones técnicas y más información, visite nuestro sitio web: [www.ortalheat.com](http://www.ortalheat.com)



FRONT FACING 



Clear 40      Clear 40H90      Clear 40H70      Clear 60X80



Clear 75X65      Clear 75      Clear 75X65 TR      Clear 90



Clear 110H      Clear 130      Clear 130H      Clear 150



Clear 150H      Clear 170      Clear 170H      Clear 200



Clear 200H      Clear 250      Clear 250H

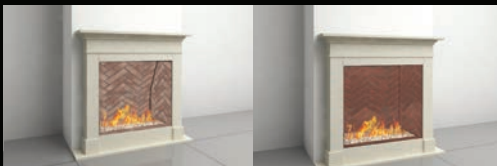

Traditional 110      Traditional 130

CORNER 



Clear 40 RS/LS      Clear 40H90 RS/LS      Clear 40H70 RS / LS      Clear 90 RS / LS



Clear 75RS / LS      Clear 110 RS / LS      Clear 110H RS / LS      Clear 130 RS / LS



Clear 130H RS / LS      Clear 150 RS / LS      Clear 150H RS / LS      Clear 170 RS / LS



Clear 170H RS / LS      Clear 200 RS / LS      Clear 200H RS / LS      Clear 250 RS / LS



Clear 250H RS / LS



# OVER 150 MODELS

THREE SIDES

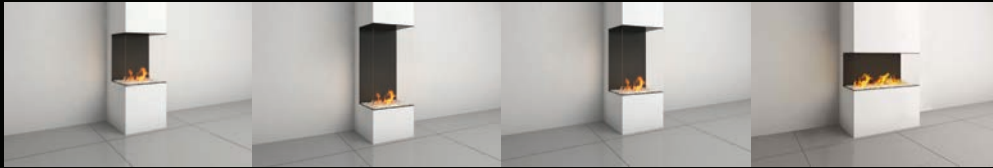

Clear 40 TS      Clear 40H90 TS      Clear 40H70 TS      Clear 90 TS



Clear 75 TS      clear 75 H      Clear 110 TS      Clear 110H TS



Clear 130 TS      Clear 130H TS      Clear 150 TS      Clear 150H TS



Clear 170 TS      Clear 170H TS      Clear 200 TS      Clear 200H TS



Clear 250 TS      Clear 250H TS

TUNNEL

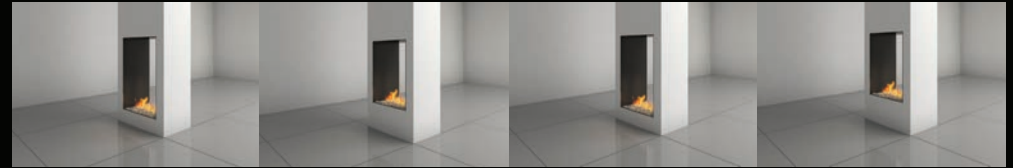

Tunnel 40      Tunnel 40H70      Tunnel 40H90      Tunnel 60X80



Tunnel 75X65      Tunnel 110      Tunnel 110H      Tunnel 130



Tunnel 130H      Tunnel 150      Tunnel 150H      Tunnel 170



Tunnel 170H      Tunnel 200      Tunnel 200H      Tunnel 250



Tunnel 250H

SPACE CREATOR 



Space Creator 75   Space Creator 90   Space Creator 120   Space Creator 150   Space Creator 200

CIRCLE & ISLAND 



Circle 70 with Bordolet Hood   Circle 70 flat hood   Circle 270 with Bordolet Hood   Circle 270 flat hood

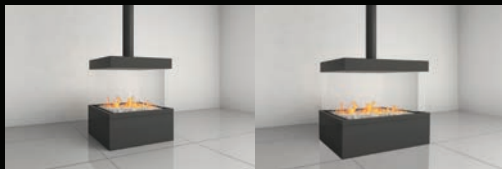

Island 70   Island 130

STAND ALONE 



Stand Alone 75   Stand Alone 110   Stand Alone 150   Stand Alone 40TS



Stand Alone 75TS   Stand Alone 110TS   Small Square   Classic F 70   Classic F 80



Classic Corner   Modern Corner   Hanging Oval 80 or 120   Wall Mounted 80 or 120

\*please visit our website for technical drawings

